

permobil Order Form - Progeo JOKER

Date

User name

Responsible

Company stamp





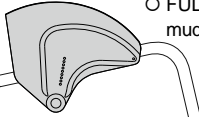

Rigid frame wheelchair
CRASH TEST APPROVED

£ 1190,00
Retail price - VAT not included

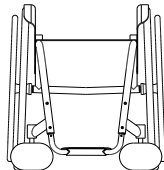
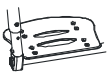
Wheelchair measures							
Seat width (LS)	<input type="checkbox"/> 33	<input type="checkbox"/> 36	<input type="checkbox"/> 39	<input type="checkbox"/> 42	<input type="checkbox"/> 45	<input type="checkbox"/> 48	
Seat depth (PS)	<input type="checkbox"/> 35	<input type="checkbox"/> 37,5	<input type="checkbox"/> 40	<input type="checkbox"/> 42,5	<input type="checkbox"/> 45	<input type="checkbox"/> 47,5	<input type="checkbox"/> 50
The real seat depth, from the front part of the seat cloth to the backrest tube will be 1,5 cm more than the declared one.							
Footplate distance (DP)	<u>(Real distance between seat and footplate)</u>						
IMPORTANT NOTICE! From the footplate to the floor minimum 4cm.!! (Minimum Front height = DP + 4cm.)							
Setting	☆ Standard		<input type="checkbox"/> Prudential	<input type="checkbox"/> Active	<input type="checkbox"/> Extreme		
Backrest Height (TS)	Std.Value 33,5(min 24.5-max 47)						
camber	☆ 0°		<input type="checkbox"/> 2°	<input type="checkbox"/> 4°			
Front height STD 49			Rear height STD 42		

Permobil Limited

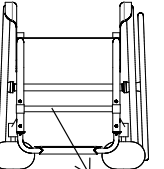
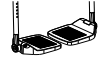
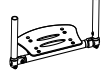
	☆ Alluminum rear adjustment plate		
	☆ Removable mudguard ABS		
	<input type="checkbox"/> Removable ABS fibre straight sideguard		
	<input type="checkbox"/> Removable carbon fibre mudguard	03946	178.00
	<input type="checkbox"/> Removable Carbon fibre straight sideguard	08918	178.00
	<input type="checkbox"/> FULL CARBON rear adjustment plate with integrated mudguard	07646	532.00
	☆ Version mudguard (Available only with rear wheels 24")		
	<input type="checkbox"/> Version straight sideguard		

JOKER		☆ Aluminium footplate, rake adjustable Minimum footplate distance 35cm. ☆ Internal <input type="checkbox"/> 2/3 Internal <input type="checkbox"/> External <input type="checkbox"/> 2/3 External		11523	no list
		<input type="checkbox"/> Aluminium footplate EVOLUTION - rake and depth adjustable Minimum footplate distance 35cm. ☆ Internal <input type="checkbox"/> 2/3 Internal <input type="checkbox"/> External <input type="checkbox"/> 2/3 External		07649	71.00
		<input type="checkbox"/> One piece Carbon fibre footplate JOKER Minimum footplate distance 35cm. not available for seat width 48		03348	143.00
		<input type="checkbox"/> One piece Carbon fibre footplate, rake adjustable Minimum footplate distance 35cm. ☆ Internal <input type="checkbox"/> External		03346	169.00
JOKER ZERO		<input type="checkbox"/> Plastic footrest, rake adjustable Minimum footplate distance 15cm. ☆ 2/3 Internal <input type="checkbox"/> 2/3 External		06814	107.00
		<input type="checkbox"/> One piece aluminium footplate - Flip-up!, rake and depth adjustable Minimum footplate distance 15cm. ☆ Internal <input type="checkbox"/> 2/3 Internal <input type="checkbox"/> External <input type="checkbox"/> 2/3 External		06856	107.00
		<input type="checkbox"/> One piece Carbon fibre footplate rake adjustable, swing away, flip-up. Minimum footplate distance 15cm. ☆ Internal <input type="checkbox"/> External		06857	275.00

customer_support_uk@permobil.com - https://www.permobil.com/en-gb

<u>Date</u>	<u>Order</u>	<u>User name</u>	<u>Address</u>
-------------	--------------	------------------	----------------

Front frame

☆ Aluminium standard frame

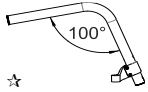

☆

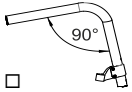

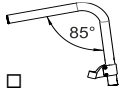

(max 4" caster)

Colour aluminium frame

☆ Bright silver

Polished black

Opaque black

Bright blue

Bright anthracite

Bright orange

Bright fuchsia

Bright red

Bright lime

Bright blue china

Pearl white

Seat

☆ Seat cloth with pocket (under seat)

Seat with tension straps 08883 **127.00**

Carbon rigid seat 08336 **269.00**

Pocket (under seat) [25x11x4,5] 08281 **42.00**

Rear wheels axle

☆ Aluminum rear wheels axle

Carbon fiber rear wheels axle **(Lightest configuration)** 07647 **84.00**

Backrest adjustment and fixing system

☆ Backrest with double locking (upright and folded)
with rake adjustable from -4° to +16°

Backrest with upright locking system ONLY (no locking when folded)
with rake adjustable from -4° to +16°

Fixed back(non-folding back)
with rake adjustable from -4° to +16°



Backrest

☆ Adjustable velcro straps and padded transpiring upholstery

☆ Aluminium backrest

Titanium backrest 06811 **107.00**

Carbon fibre backrest 04389 **424.00**









AIR Integrated posture backrest (NOT REMOVABLE) **593.00**

Carbon shell - Lateral retaining 7,5cm
Depth adjustment ±1cm. - Angle adjustment ±10°
not available for seat width 48

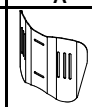
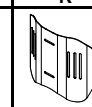
H 28	H 34	H 40
Backrest Height (TS) min 34	Backrest Height (TS) min 38	Backrest Height (TS) min 44
(.....)	(.....)	(.....)

Lateral retaining wing A=high - R=regular

A	R	A	R	A	R
					
<input type="checkbox"/>	<input type="checkbox"/>	<input type="checkbox"/>	<input type="checkbox"/>	<input type="checkbox"/>	<input type="checkbox"/>



Installation on:

☆ Backrest tubes

Aluminium backrest

Titanium backrest 06811 **107.00**

Carbon fibre backrest 04389 **424.00**

Permobil Limited

customer_support_uk@permobil.com - https://www.permobil.com/en-gb

<u>Date</u>	<u>Order</u>	<u>User name</u>	<u>Address</u>
-------------	--------------	------------------	----------------

Handle tube

☆ Tubes with standard handle

Tubes with short handle

SPORT tubes Without push handles

Carbon fibre tubes with short handle (Lightest configuration) 04390 **84.00**

Not available with: Posture backrest PHYSIO - Posture backrest A I R

Folding handles 02958 **143.00**



Casters

☆ 4" Soft (Lightest configuration)

3" Sport

5" Soft

6" Soft (Available only with 100° angle)

6" Pneumatic (Available only with 100° angle)

3" Active Soft (wide) (Aluminium alloy rim) 06824 **71.00**

4" Active Sport (narrow) (Aluminium alloy rim) 01398 **71.00**

4" Active Soft (wide) (Aluminium alloy rim) 03943 **71.00**

5" Active Soft (wide) (Aluminium alloy rim) 07518 **71.00**

5" Pneumatic 10844 **35.00**

Colour set: Rear wheels and forks - To be matched only with: Rear wheels Ultra-light Progeo - Standard! (22 - 24)

☆ Black 22" 24" 25" 26" 00833 **71.00**

Bright silver 22" 24" 00833 **71.00**

Bright anthracite 24" 00833 **71.00**

Bright orange 22" 24" 00833 **71.00**

Bright fuchsia 22" 24" 00833 **71.00**

Bright blue 22" 24" 00833 **71.00**

Bright red 22" 24" 00833 **71.00**

Bright lime 22" 24" 00833 **71.00**

Pearl white 22" 24" 00833 **71.00**

Rear wheels

☆ 24" Ultra-light Progeo - Standard!

22" Ultra-light Progeo - Standard!

25" Ultra-light Progeo - Standard! (colour: black)

26" Progeo - Standard! (colour: black)

24" ULTRA-LIGHT PROGEO KEY SPORT **Weight reduction approx. 450gr.** 04383 **496.00**

24" Ultra-light "Spinergy LX" 01685 **496.00**

24" Ultra-light "Spinergy LXL" Black hub and white spokes Hub and spokes black 07846 **496.00**

24" Ultra-light "Spinergy Flex rim" **Integrated aluminium/rubber handrim** 02270 **778.00**

25" Ultra-light "Spinergy LX" 02101 **496.00**

25" Ultra-light "Spinergy LXL" Black hub and white spokes 07847 **496.00**

26" Ultra-light "Spinergy LX" 02102 **496.00**

24" Off-road (aluminium handrim black) 01392 **127.00**

Rear wheel tyre

☆ High pressure tyre (22"-24"-25"-26") (Lightest configuration)

High pressure profile tyre (24")

Marathon Plus (24"-25") **with anti-puncture protection** 01669

Anti-puncture - Colour Grey (22") 04181 **55.00**

Anti-puncture - Colour Black (24") 11083 **71.00**

Anti-puncture - Colour Grey (24") 11083 **71.00**

Handrim Wheel distance ☆ 3 cm 4 cm

☆ Aluminium (22"-24"-25"-26") (Lightest configuration) 09170 **71.00**

Aluminium black SOFT-TOUCH (24"-25") (24" handrim, on 25" wheel is installed with spacers) 01684 **84.00**

Chromed Steel (24"-25") (24" handrim, on 25" wheel is installed with spacers) 00016 **155.00**

Titanium (24"-25") (24" handrim, on 25" wheel is installed with spacers) 00017 **178.00**

Ultra Grepp (24"-25") (24" handrim, on 25" wheel is installed with spacers) 00834 **197.00**

Max Grepp (24"-25") (24" handrim, on 25" wheel is installed with spacers) 00632 **197.00**

Ergo Para (24") 11023 **226.00**

TOP FRICTION (24"-25") (24" handrim, on 25" wheel is installed with spacers)

Oval countour with a rubber insert

NOVA H (24"-25") (24" handrim, on 25" wheel is installed with spacers) 11025 **149.00**

Ergonomic black profile

NOVA D (24"-25") (24" handrim, on 25" wheel is installed with spacers) 11026 **162.00**

Ergonomic profile with rubber coating (ideal for quadriplegics)







SURGE LT (25") **Oval countour with a rubber insert** 06427 **204.00**

Quad (24") (24") 00693 **113.00**

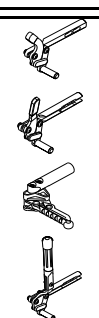
Silicon cover for standard aluminium handrim **Available for measures (22"- 24" - 26")** 04050 **91.00**

Permobil Limited

customer_support_uk@permobil.com - https://www.permobil.com/en-gb

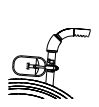
Date	Order	User name	Address
Wheel locks			
<input checked="" type="checkbox"/> Bent lever push to lock <input type="checkbox"/> Straight lever push to lock <input type="checkbox"/> Straight lever pull to lock <input type="checkbox"/> Sport brake <input type="checkbox"/> Brake with extension lever push to lock <input type="checkbox"/> Brake with extension lever pull to lock		(Lightest configuration)	 06428 71.00 01949 35.00 03372 35.00
Armrests			
<input type="checkbox"/> Tubular armrests		(Swing away, removable and height adjustable armrest)	 00694 143.00
Accessories			
<input type="checkbox"/> Pad for front frame protectors <input type="checkbox"/> Backrest-seat connection cloth <input type="checkbox"/> Removable storage bag (with quick coupling)			07058 29.00 10241 10.00 09811 71.00
SAFETY			
<input type="checkbox"/> 4 points tie-down system rings			 08654 107.00
Optional 1			
<u>Only one optional devices for side can be chosen</u>			
<input type="checkbox"/> Transit wheels		Exclude the installation of Anti-tippers	 03290 84.00
<input type="checkbox"/> Anti-tipper BASE		Exclude the installation of Transit wheels <input type="checkbox"/> Right <input type="checkbox"/> Left	06819 80.00 06820 80.00
<input type="checkbox"/> Anti-tipper with rapid hookup (inside rotation to reduce the encumbrance)		Exclude the installation of Transit wheels <input type="checkbox"/> Right <input type="checkbox"/> Left	 06821 71.00 06822 71.00
Optional 2			
<input type="checkbox"/> Push handles for companion		(Removable and height adjustable)	 03645 100.00
<input type="checkbox"/> Tetracrip		(Quick release axle for quadriplegic)	03947 100.00
<input type="checkbox"/> Safety pelvic belt			03972 25.00
<input type="checkbox"/> Lumbar support		(to insert in the backrest upholstery)	00013 23.00
<input type="checkbox"/> Swing away lateral support		Not available with Posture backrest PHYSIO - Posture backrest A I R <input type="checkbox"/> Right <input type="checkbox"/> Left	 02097 143.00 02098 143.00
<input type="checkbox"/> Spoke guards Black <input type="checkbox"/> Spoke guards Transparent <input type="checkbox"/> Spoke guards Progeo design <input type="checkbox"/> Spoke guards Dragon		(22"-24") (22"-24") (22"-24") (22"-24")	01043 84.00 00835 50.00 00019 100.00 02106 100.00
Additional Kit			
<input type="checkbox"/> 24" Off-road rear wheels <input type="checkbox"/> 24" FAT rear wheels		Off-Road tyre - aluminium handrim (black colour) FAT tyre 3" - aluminium handrim (black colour)	03378 282.00 09357 496.00

Permobil Limited

customer_support_uk@permobil.com - https://www.permobil.com/en-gb

Date Order User name Address

PHYSIO - Posture backrest - Std. Backrest upholstery not provided

Removable with quick release
 Suitable for tubes with diameter 18÷26mm
 Depth adjustment (4cm)
 Angle adjustment (±18°)

- AIR** Carbon shell
 not available for seat width 48

BACKREST HEIGHT	28	34	40	574.00
Shell's shape 7,5 cm	Lateral retaining wing A=high - R=regular			
	A	R	A	R

- POSTURE** Aluminum shell

BACKREST HEIGHT	34	40	52	574.00
Shell's shape 7,5 cm	Lateral retaining wing B=regular			
	R	R	R	

Configuration DEEP with side support PAD (height adjustable)

- Alluminum lateral with padded, breathable upholstery.



Small (h 13cm)



- Right 10272
- Left 10272

16.00
16.00

Large (h 20cm)



- Right 10273
- Left 10273

23.00
23.00

SWING AWAY - Lateral support

Fixing and adjustment hardware complete with protection sleeve
 Alluminum lateral with padded, breathable upholstery.

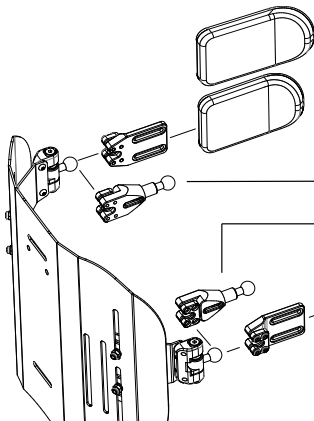

- Large (18x12)

05647 104.00

- Small (14x9)

05643 104.00

- Lateral support extension

Quantity (number pcs) (.....)

10271 39.00

- Lateral support extension

Quantity (number pcs) (.....)

- Small (14x9)

05642 104.00

- Large (18x12)

05646 104.00

- Headrest adjustable - Double ball mounting system

Available only with backrest Physio
 Not available for backrest Physio AIR carbon shell



- Large (34x14)
- Small (28x14)

05648 143.00

Permobil Limited

customer_support_uk@permobil.com - https://www.permobil.com/en-gb

Date	Order	User name	Address
------------	-------------	-----------------	---------------



Note

Wheelchair : Progeo JOKER - Rev. 2022.4	Prices - VAT excluded to be added to the price list	Send this page only if any optional have been chosen <input checked="" type="checkbox"/> standard (supplied if no requests are indicated) <input type="checkbox"/> on request (without extra charge) <input type="checkbox"/> optional (cost to be added at the basic price)
---	--	---

Permobil Limited

customer_support_uk@permobil.com - https://www.permobil.com/en-gb

REFERENCE TABLES

1		Front height			
		With closed frame (95°) max 5" caster			
		With closed frame (90°) max 5" caster			
		With closed frame (85°) max 4" caster			
		Casters			
FORK		3"	4"	5"	6"
SPORT 		max 52	max 53	max 54	
SMALL 		max 54	max 55	max 56	max 57
MEDIUM 		max 56	max 57	max 58	max 59
The size of the fork will be defined only by Progeo in accordance with wheelchair final configuration.					

2		Rear height			
		Rear wheels			
		22"	24"	25"	26"
min	36	min 38	min 39	min 40	
max	44	max 46	max 47	max 48	

3		Footplate option	Footplate distance
		Aluminium footplate rake adjustable	min 35
		One piece Carbon fibre footplate	min 35
		One piece Carbon fibre footplate rake adjustable	min 35
		Plastic footrest, rake adjustable	min 35
		One piece aluminium footplate - Flip-up!, rake and depth adjustable	min 35
		One piece Carbon fibre footplate rake adjustable, swing away, flip-up.	min 35
IMPORTANT NOTICE! From the footplate to the floor minimum 4cm.!! (Minimum Front height = DP + 4cm.)			
Calculated with the best configuration and with the footplates positioned on inside.			
NOTE! Lower footplate distances are possible only after our valuation			

4		Rear wheels	
Model		Features	
22" Ultra-light Progeo - Standard!		(not available in anthracite color)	
24" Ultra-light Progeo - Standard!		(available for all colours)	
24" ULTRA-LIGHT PROGEO KEY SPORT		(silver hub, black rim and 16 spokes)	
24" Ultra-light "Spinergy LX"		(silver hub, black rim and spokes)	
24" Ultra-light "Spinergy LXL"		(black hub and rim, 18 white spokes) - (black hub, rim and 18 spokes)	
24" Ultra-light "Spinergy Flex rim"		(silver hub, black rim and spokes) - (integrated aluminium/rubber handrim - encumbrance reduction up to 3cm. - all tyre)	
24" Off-road		(colour: black) - (aluminium handrim - tyre Off-road)	
25" Ultra-light "Spinergy LX"		(silver hub, black rim and spokes)	
25" Ultra-light "Spinergy LXL"		(black hub and rim, 18 white spokes)	
26" Progeo - Standard!		(colour: black)	
26" Ultra-light "Spinergy LX"		(silver hub, black rim and 18 spokes)	

Wheelchair : Progeo JOKER - Rev. 2022.4

Permobil Limited

customer_support_uk@permobil.com - https://www.permobil.com/en-gb