

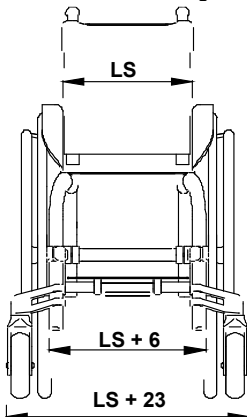
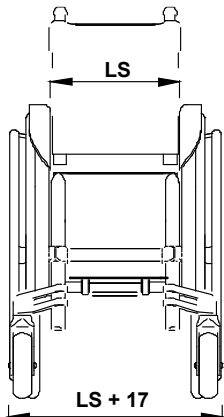
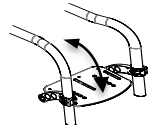

Date .....	<b>SCOTLAND (English)</b>	Rigid frame wheelchair CRASH TEST APPROVED
User .....	Company stamp	
End user weight (kg) .....		<b>£ 1190,00</b>
Language user manual .....	Responsible .....	<b>Retail price - VAT not included</b>

Wheelchair measures	
Seat width (LS) <input type="checkbox"/> 24 <input type="checkbox"/> 27 <input type="checkbox"/> 30 <input type="checkbox"/> 33 <input type="checkbox"/> 36	
Seat depth (PS) <input type="checkbox"/> 27,5 <input type="checkbox"/> 30 <input type="checkbox"/> 32,5 <input type="checkbox"/> 35 <input type="checkbox"/> 37,5 <input type="checkbox"/> 40 <small>Seat depth can be increased by 2,5 or 5 cm.</small>	
Footplate distance (DP) ..... min 8 - max 39,5 (cm) ±0.5cm - adjustment steps 1.5cm <small>(Real distance between seat and footplate) - IMPORTANT NOTICE! From the footplate to the floor minimum 4cm !! (Minimum Front height = DP + 4cm.)</small>	
Setting <input checked="" type="checkbox"/> Standard <input type="checkbox"/> Prudential <input type="checkbox"/> Active	
Backrest Height (TS) Std.Value 33,5 .....(min 29 - max 51) adjustment steps 1.5cm	
camber <input checked="" type="checkbox"/> 0° <input type="checkbox"/> 2° <input type="checkbox"/> 4°	
Front height ..... (STD 45) Casters 3" (min 35 - max 51) Casters 4" (min 35 - max 52) Casters 5" (min 32 - max 52) <small>The difference between Front Height and Footplate distance must be greater than 10cm</small>	Rear height ..... (STD 41) Rear wheels 22" (min 35 - max 45) Rear wheels 24" (min 37 - max 47)

Front frame		
☆ Aluminium frame - Angle 95°		
 <p>☆ Frame with abduction</p>	 <p><input type="checkbox"/> Straight frame</p>	<p><b>Colour aluminium frame</b></p> <ul style="list-style-type: none"> <li>☆ Bright silver</li> <li><input type="checkbox"/> Opaque black</li> <li><input type="checkbox"/> Bright blue</li> <li><input type="checkbox"/> Bright fuchsia</li> <li><input type="checkbox"/> Bright red</li> <li><input type="checkbox"/> Bright lime</li> <li><input type="checkbox"/> Pearl white</li> <li><input type="radio"/> Opaque orange</li> </ul> <p style="text-align: right;"><b>08341 38,00</b></p>

Footplate
☆ One piece aluminium footplate - Flip-up! FLIP-UP! - rake and depth adjustable
<b>Footplate distance (min 8 - max 39,5)</b>
 <p>11524</p>

Backrest with double locking (upright and folded) ( with rake adjustable from -4° to +16°)
☆ Aluminium backrest
☆ Adjustable velcro straps and padded transpiring upholstery

Handle tube
☆ Tubes with standard handle
<input type="checkbox"/> Folding handles
 <p>02958 151,00</p>

Fork colour	Colour rear wheels
☆ Black	To be matched only with: Rear wheels Ultra-light Progeo - Standard! (22 - 24)
<input type="radio"/> Bright silver <input type="radio"/> Bright anthracite <input type="radio"/> Pearl white <input type="radio"/> Bright red	<input checked="" type="checkbox"/> Black <input type="radio"/> Bright silver <input type="radio"/> Bright anthracite (24") <input type="radio"/> Pearl white <input type="radio"/> Bright red
<input type="radio"/> Bright orange <input type="radio"/> Bright blue <input type="radio"/> Bright fuchsia <input type="radio"/> Bright lime	<input type="radio"/> Bright orange <input type="radio"/> Bright blue <input type="radio"/> Bright fuchsia <input type="radio"/> Bright lime
<b>08342 38,00</b>	<b>04692 38,00</b>

Date .....	Order .....	User .....	Address .....
------------	-------------	------------	---------------

<b>Casters</b>			
☆ 4" Soft			
<input type="checkbox"/> 3" Sport			
<input type="checkbox"/> 5" Soft			
<input type="radio"/> 3" Active Soft (wide)	(Aluminium alloy rim)	06824	76,00
<input type="radio"/> 4" Active Sport (narrow)	(Aluminium alloy rim)	01398	76,00
<input type="radio"/> 4" Active Soft (wide)	(Aluminium alloy rim)	03943	76,00
<input type="radio"/> 5" Active Soft (wide)	(Aluminium alloy rim)	07518	76,00
<input type="radio"/> 5" Pneumatic		10844	38,00

<b>Rear wheels</b>			
☆ 24" Ultra-light Progeo - Standard!			
<input type="checkbox"/> 22" Ultra-light Progeo - Standard!			
<input type="radio"/> 24" ULTRA-LIGHT PROGEO KEY SPORT	Weight reduction approx. 450gr.	04383	526,00
<input type="radio"/> 24" Ultra-light "Spinergy LX"		01685	526,00
<input type="radio"/> 24" Ultra-light "Spinergy LXL"	<input type="checkbox"/> Black hub and white spokes <input type="checkbox"/> Hub and spokes black	07846	526,00
<input type="radio"/> 24" Ultra-light "Spinergy Flex rim"	Integrated aluminium/rubber handrim	02270	824,00
<input type="radio"/> 24" Off-road (aluminium handrim black)		01392	134,00

<b>Rear wheel tyre</b>			
☆ High pressure tyre	(22"-24")		
<input type="checkbox"/> High pressure profile tyre	(24")		
<input type="radio"/> Marathon Plus	(24")	with anti-puncture protection	01669 38,00
<input type="radio"/> Anti-puncture - Colour Grey	(22")		04181
<input type="radio"/> Anti-puncture - Colour Black	(24")		11083 76,00

<b>Handrim</b>	<b>Wheel distance</b> ☆ 3 cm <input type="checkbox"/> 4 cm		
☆ Aluminium	(22"-24")		
<input type="radio"/> Aluminium black SOFT-TOUCH	(24")	09170	76,00
<input type="radio"/> Chromed Steel	(24")	01684	89,00
<input type="radio"/> Titanium	(24")	00016	165,00
<input type="radio"/> Ultra Grepp	(24")	00017	189,00
<input type="radio"/> Max Grepp	(24")	00834	209,00
<input type="radio"/> Ergo Para	(24")	00632	209,00
<input type="radio"/> TOP FRICTION	(24")	11023	239,00
Oval countour with a rubber insert			
<input type="radio"/> NOVA H	(24")	11025	158,00
Ergonomic black profile			
<input type="radio"/> NOVA D	(24")	11026	172,00
Ergonomic profile with rubber coating (ideal for quadriplegics)			
<input type="radio"/> Quad	(24")	00693	120,00
<input type="radio"/> Silicon cover for standard aluminium handrim	Available for measures (22"-24")	04050	96,00

<b>Wheel locks</b>			
☆ Bent lever push to lock			
<input type="checkbox"/> Straight lever push to lock			
<input type="checkbox"/> Straight lever pull to lock			
<input type="radio"/> Brake with extension lever push to lock		01949	38,00
<input type="radio"/> Brake with extension lever pull to lock		03372	38,00

Date ..... Order ..... User ..... Address .....

**Mudguard**

- ☆ Removable ABS mudguard
- Removable ABS fibre straight sideguard
- Removable carbon fibre mudguard  03946 **189,00**
- Removable Carbon fibre straight sideguard 03946 **189,00**

**Armrests**

Tubular armrests (Swing away, removable and height adjustable armrest)  04828 **106,00**

Height assembly (to the seat):  27  28,5  30  31,5  33  34,5  36

**Removable armrest with ABS mudguard**

- Removable armrest with ABS straight sideguard  08881 **134,00**
- Removable armrest with carbon-fiber straight sideguard 08882 **272,00**

**SAFETY**

- 4 points tie-down system rings  08654 **113,00**  
The use of a headrest during transport is mandatory (installation must be carried out by the manufacturer)



**Accessories**

- Pad for front frame protectors 07058 **31,00**
- Backrest-seat connection cloth 10241 **10,00**
- Removable storage bag (with quick coupling) 09811 **76,00**

**Optional 1**

- Anti-tipper with rapid hookup (inside rotation to reduce the encumbrance)  06821 **76,00**  
 Right 06822  
 Left

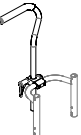
**Optional 2**

- One piece Push handle for companion (Removable and height adjustable)  08930 **106,00**
- Push handles for companion (Removable and height adjustable)  03645 **106,00**
- Tetraclip (Quick release axle for quadriplegic) 03947 **106,00**
- Safety pelvic belt 03972 **38,00**
- Harness 04103 **76,00**
- Lumbar support (to insert in the backrest upholstery) 00013 **24,00**
- Swing away lateral support Not available with: Posture backrest PHYSIO - Posture backrest A I R  02097 **151,00**  
 Right 02098 **151,00**  
 Left
- Spoke guards Black (22"-24") 01043 **89,00**
- Spoke guards Transparent (22"-24") 00835 **89,00**
- Spoke guards Progeo design (22"-24") 00019 **106,00**
- Spoke guards Dragon (22"-24") 02106 **106,00**

**Additional Kit**

- 24" Off-road rear wheels Off-Road tyre - aluminium handrim (black colour) 03378 **299,00**
- 24" FAT rear wheels FAT tyre 3" - aluminium handrim (black colour) 09357 **526,00**

Date ..... Order ..... User ..... Address .....

### PHYSIO - Std. Backrest upholstery not provided



Removable with quick release  
 Suitable for tubes with diameter 18+26mm  
 Depth adjustment (4cm)  
 Angle adjustment ( $\pm 18^\circ$ )

### Posture backrest KID JUNIOR VERSION

- KID** Aluminum shell

**WARNING:** with this backrest the seat depth is reduced by 5 cm approx.



*not available for seat width 24*

BACKREST HEIGHT	29	34	40	608,00
Shell's shape	Lateral retaining wing B=regular			
	R	R	R	
 	<input type="checkbox"/>	<input type="checkbox"/>	<input type="checkbox"/>	

### Posture backrest ADULT VERSION



- AIR** Carbon shell

*not available for seat width 27 - 30*

BACKREST HEIGHT	28	34	40	628,00
Shell's shape	Lateral retaining wing A=high - R=regular			
	A	R	A	R
 	<input type="checkbox"/>	<input type="checkbox"/>	<input type="checkbox"/>	<input type="checkbox"/>

- POSTURE** Aluminum shell

*not available for seat width 27 - 30*

BACKREST HEIGHT	34	40	52	608,00
Shell's shape	Lateral retaining wing B=regular			
	R	R	R	
 	<input type="checkbox"/>	<input type="checkbox"/>	<input type="checkbox"/>	

### Configuration DEEP with side support PAD (height adjustable)

- Alluminum lateral with padded, breathable upholstery.



Small (h 13cm)	Large (h 20cm)
 <input type="checkbox"/> Right 10272	 <input type="checkbox"/> Right 10273
 <input type="checkbox"/> Left 10272	 <input type="checkbox"/> Left 10273
17,00	24,00

Date .....	Order .....	User .....	Address .....
------------	-------------	------------	---------------

**Accessories**

### *KID AIR POSTURE*

SWING AWAY - Lateral support  
 Not available for backrest Physio AIR carbon shell  
 Fixing and adjustment hardware complete with protection sleeve  
 Alluminum lateral with padded, breathable upholstery.

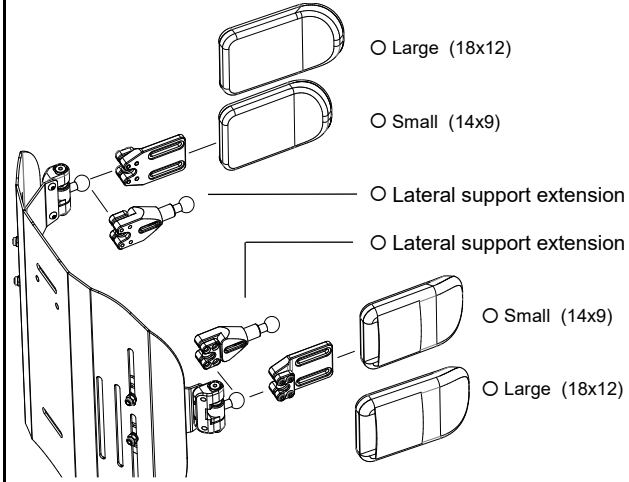

Large (18x12)

05647 110,00

Small (14x9)

05643 110,00

Lateral support extension

Quantity (number pcs).....

10271 41,00

Lateral support extension

Quantity (number pcs).....

Small (14x9)

05642 110,00

Large (18x12)

05646 110,00

Headrest adjustable - Double ball mounting system  
 Not available for backrest Physio AIR carbon shell

Large (34x14)  
 Small (28x14)



05648 151,00

<b>Wheelchair : Progeo JOKER JUNIOR 2.0 - Rev. 2023.3</b>	Prices - VAT excluded to be added to the price list	<p style="text-align: center; font-weight: bold; font-size: small;">Send this page only if any optional have been chosen</p> <table style="width: 100%; border-collapse: collapse;"> <tr> <td style="width: 10%; text-align: center;">☆</td> <td style="width: 60%;">standard</td> <td style="width: 30%; font-size: x-small;">(supplied if no requests are indicated)</td> </tr> <tr> <td style="text-align: center;">□</td> <td>on request</td> <td style="font-size: x-small;">(without extra charge)</td> </tr> <tr> <td style="text-align: center;">○</td> <td>optional</td> <td style="font-size: x-small;">(cost to be added at the basic price)</td> </tr> </table>	☆	standard	(supplied if no requests are indicated)	□	on request	(without extra charge)	○	optional	(cost to be added at the basic price)
☆	standard	(supplied if no requests are indicated)									
□	on request	(without extra charge)									
○	optional	(cost to be added at the basic price)									