

permobil NHS Order Form - Progeo EASY TILT

CRASH TEST APPROVED

UK (English)

Date
 User
 End user weight (kg)
 Language user manual
 Company stamp
 Responsible

Rigid tilting frame wheelchair

£ 1980,00

Information on end user

End user pathology :

Presence of dystonia or important spasms : YES NO

End user weight (kg):.....Kg

MODEL ADULT

MODEL JUNIOR

Seat width (LS)

33 36 39 42 45 48

30 33 36 39

kit to increase seat width (LS + 3cm) - included on the basic price

kit to increase seat width (LS + 3cm) - included on the basic price

☆ Not mounted (LS)
 Mounted (LS + 3cm)

☆ Not mounted (LS)
 Mounted (LS + 3cm)

Seat depth (PS) - adjustable!

Short frame
 35 37,5 40

Medium frame
 40 42,5 45

Long frame
 45 47,5 50

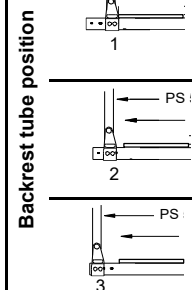
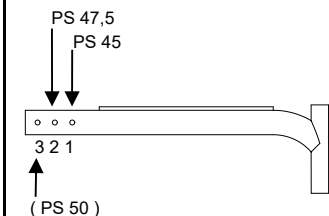
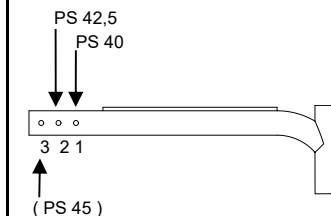
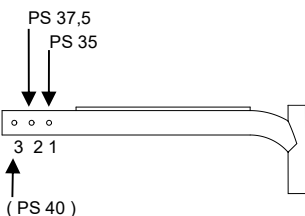

Footplate distance (DP) - (Real distance between seat and footplate)

IMPORTANT NOTICE! From the footplate to the floor minimum 4cm !! (Minimum Front height = DP + 4cm.)

Minimum footplate distance ~22cm

.....(cm) ±0.5cm - adjustment steps 1.5cm

Seat height (parallel to the ground)

CASTERS 6"	Rear wheels			
	12"	16"	22"	24"
<input type="checkbox"/> 42		<input type="checkbox"/> 42		
☆ 43,3		<input type="checkbox"/> 43,3		<input type="checkbox"/> 43,3
<input type="checkbox"/> 44,5		<input type="checkbox"/> 44,5		<input type="checkbox"/> 44,5
<input type="checkbox"/> 45,8		<input type="checkbox"/> 45,8		<input type="checkbox"/> 45,8
<input type="checkbox"/> 47		<input type="checkbox"/> 47		<input type="checkbox"/> 47
	<input type="checkbox"/> 47			<input type="checkbox"/> 48,3
		<input type="checkbox"/> 48,3		

CASTERS 7"	Rear wheels			
	12"	16"	22"	24"
			<input type="checkbox"/> 44,5	<input type="checkbox"/> 44,5
	<input type="checkbox"/> 44,5		<input type="checkbox"/> 45,8	<input type="checkbox"/> 45,8
	<input type="checkbox"/> 45,8		<input type="checkbox"/> 47	<input type="checkbox"/> 47
	<input type="checkbox"/> 47		<input type="checkbox"/> 48,3	<input type="checkbox"/> 48,3

Front frame

☆ Straight frame

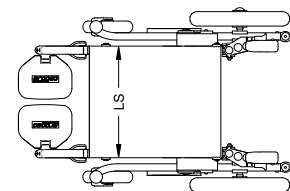

Front frame, swing away, and removable

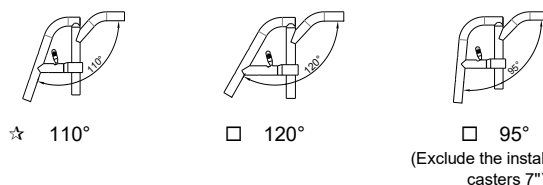

Frame with abduction 6cm
 not available for seat width 42 - 45 - 48

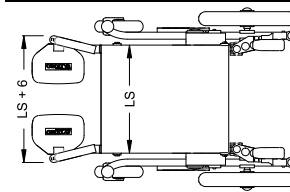

Front frame, swing away, and removable



Elevating front frame, swing away and removable
 not available for seat width 30 - 33
 Minimum footplate distance 22cm.

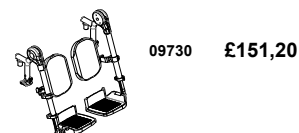

Date Order User Address

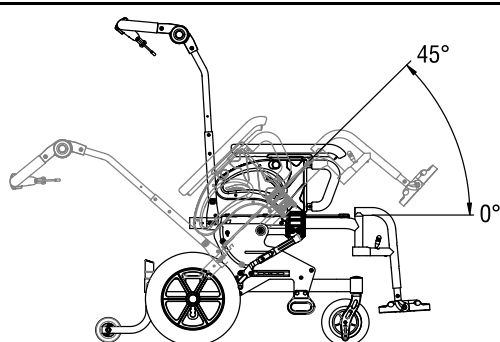

☆ STD tilt (0 → 45°)

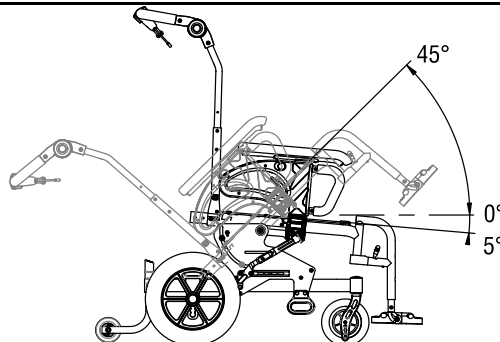

WITH front negative tilt (-5° → 45°)

SAFETY

- 4 points tie-down system rings
- The use of a headrest during transport is mandatory (installation must be carried out by the manufacturer)**



08654 £113.40

Frame colour (without extra charge)

- Opaque black
- Opaque orange
- AVIO blue - NEW!
- Pearl white

Frame colour on request

- Bright red
- Bright fuchsia
- Bright lime
- Bright blue china

09729 £151.20

Backrest

- ☆ Reclining and folding backrest
- Easy adjustment of the reclining on three positions

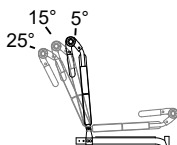

One piece Push handle for companion

- Free positioning
- It allows the positioning of the height of the one push handle according to the helper (independent from the backrest height - quick setting)

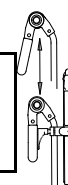

01048 £113.40

Backrest upholstery

- ☆ WITH NO backrest upholstery, NOR tension adjustment straps
- Backrest Height (TS)** ☆ 42 48 Available until 54cm
- WITH backrest upholstery and tension adjustment straps. Complete with backrest-seat connection cloth.
- With fixed back(non-folding back)->minimum height 39cm
- Backrest Height (TS)** ☆ 42 48 Available until 54cm

04693 £75.60

Casters

- ☆ 6" Soft
- 6" Pneumatic
- 7" Soft
- Not available with: Front frame 95°**

Rear wheels

- ☆ 12" transit rear wheels - Anti-puncture
- 12" transit rear wheels - Pneumatic
- 16" transit rear wheels - Pneumatic
- 24" Ultra-light Progeo - Standard! 04696 £75.60
- 22" Ultra-light Progeo - Standard! 04696 £75.60
- 24" Ultra-light "Spinergy LX" 04691 583.80
- 24" Ultra-light "Spinergy LXL" Black hub and white spokes Hub and spokes black 07848 583.80
- 24" Ultra-light "Spinergy Flex rim" **Integrated aluminium/rubber handrim** 02270 824.40
- 24" Off-road (aluminium handrim black) 04690 189,00
- 12" with brake handles for companion (drum brake) Anti-puncture Pneumatic 04105 189,00
- 16" with brake handles for companion (drum brake) - Pneumatic 04107 189,00
- 22" with brake handles for companion (drum brake) (aluminium handrim) 03385 216,00
- 24" with brake handles for companion (drum brake) (aluminium handrim) 03384 216,00

Colour rear wheels - To be matched only with:Rear wheels Ultra-light Progeo - Standard!

- ☆ Polished black 22-24" 04692 37,80
- Bright silver 22-24" 04692 37,80
- Bright anthracite 24" 04692 37,80
- Bright orange 22-24" 04692 37,80
- Bright fuchsia 22-24" 04692 37,80
- Bright blue 22-24" 04692 37,80
- Bright red 22-24" 04692 37,80
- Bright lime 22-24" 04692 37,80
- Pearl white 22-24" 04692 37,80

Date Order User Address

Handrim	Wheel distance ☆ 3 cm	□ 4 cm		
☆ Aluminium	(22-24")			
○ Aluminium black SOFT-TOUCH	(24")		09170	75,60
○ Chromed Steel	(24")		01684	88,80
○ Titanium	(24")		00016	165,00
○ Ultra Grepp	(24")		00017	189,00
○ Max Grepp	(24")		00834	209,40
○ Ergo Para	(24")		00632	209,40
○ TOP FRICTION	(24"-25")	(24" handrim, on 25" wheel is installed with spacers)	11023	239,40
Oval countour with a rubber insert				
○ NOVA H	(24"-25")	(24" handrim, on 25" wheel is installed with spacers)	11025	157,80
Ergonomic black profile				
○ NOVA D	(24"-25")	(24" handrim, on 25" wheel is installed with spacers)	11026	171,60
Ergonomic profile with rubber coating (ideal for quadriplegics)				
○ SURGE LT	(25")	Oval countour with a rubber insert	06427	216,00
○ Quad	(24")		00693	120,00
○ Silicon cover for standard aluminium handrim		Available for measures (22"-24")	04050	96,00

Rear wheel tyre				
☆ High pressure tyre	(22-24")			
□ High pressure profile tyre	(24")			
○ Marathon Plus	(24")	with anti-puncture protection	01669	37,80
○ Anti-puncture - Colour Grey	(22")		04181	98,00
○ Anti-puncture - Colour Black	(24")		11083	126,00

Wheel locks				
☆ Bent lever push to lock				
□ Straight lever push to lock				
□ Straight lever pull to lock				
○ Brake with extension lever push to lock			01949	63,00
○ Brake with extension lever pull to lock			03372	63,00

Footplate (Not available with Elevating front frame, swing away and removable)				
☆ Plastic footrest, rake adjustable			11525	
Minimum footplate distance ~19cm				
Not available with: Front frame with levating footrest, swing away and removable				
○ One piece aluminium footplate - Flip-up! rake and depth adjustable			09727	75,60
Not available for seat width 30 with straight front frame				
Minimum footplate distance ~18cm				
Not available with: Front frame with levating footrest, swing away and removable				
	□ Internal	☆ 2/3 Internal	□ 2/3 External	□ External

Removable armrest with ABS mudguard				
☆ Desk armrests PROGEO		(Removable and height adjustable)		

Accessories				
○ Pad for front frame protectors			07058	31,20
○ Removable storage bag (with quick coupling)			09811	75,60

Optional 1				
☆ Anti-tipper with tipping aid integrated		(inside rotation to reduce the encumbrance)		
INCLUDED ON THE BASIC PRICE				
○ Anti-tippers with rapid hookup		(inside rotation to reduce the encumbrance)	11033	88,80
○ Transit wheels			00836	88,80
○ Tipping aid	○ Right		00025	44,40
	○ Left		01046	44,40
○ Crutches support	○ Right		00838	44,40
	○ Left		00837	44,40

Optional 2				
○ Harness			04103	75,60
○ Safety pelvic belt			03972	37,80
○ Tray table (removable)			00508	165,00
○ Lumbar support		(to insert in the backrest upholstery)	00013	24,00
○ Spoke guards Black		(22-24")	01043	88,80
○ Spoke guards Transparent		(22-24")	00835	88,80
○ Spoke guards Progeo design		(22-24")	00019	106,20
○ Spoke guards Dragon		(22-24")	02106	106,20

Date Order User Address

Permobil Limited Unit 7, Polaris Centre, 41 Brownfields, Welwyn Garden City, Herts, AL7 1AN United Kingdom - Phone: +44 1484 722888

PHYSIO - Std. Backrest upholstery not provided

Removable with quick release
 Suitable for tubes with diameter 18÷26mm
 Depth adjustment (4cm)
 Angle adjustment ($\pm 18^\circ$)

Posture backrest KID JUNIOR VERSION

- KID** Aluminum shell

WARNING: with this backrest the seat depth is reduced by 5 cm approx.

BACKREST HEIGHT	29	34	40	607.80
Shell's shape	Lateral retaining wing B=regular			
 3.5 cm	R	R	R	
	<input type="checkbox"/>	<input type="checkbox"/>	<input type="checkbox"/>	

Posture backrest ADULT VERSION

- AIR** Carbon shell
not available for seat width 30

BACKREST HEIGHT	28	34	40	628.20		
Shell's shape	Lateral retaining wing A=high - R=regular					
 7.5 cm	A	R	A	R	A	R
	<input type="checkbox"/>	<input type="checkbox"/>	<input type="checkbox"/>	<input type="checkbox"/>	<input type="checkbox"/>	<input type="checkbox"/>

- POSTURE** Aluminum shell
not available for seat width 30

BACKREST HEIGHT	34	40	52	607.80
Shell's shape	Lateral retaining wing B=regular			
 7.5 cm	R	R	R	
	<input type="checkbox"/>	<input type="checkbox"/>	<input type="checkbox"/>	

Configuration DEEP with side support PAD (height adjustable)

- Aluminum lateral with padded, breathable upholstery.



Small (h 13cm)	Large (h 20cm)
 <input type="checkbox"/> Right 10272 29,00	 <input type="checkbox"/> Right 10273 24.00
 <input type="checkbox"/> Left 10272 29,00	 <input type="checkbox"/> Left 10273 24.00





customer_support_uk@permobil.com - https://www.permobil.com/en-gb

Date Order User Address

Accessories

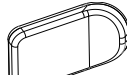
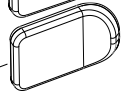
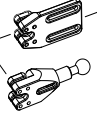
KID AIR POSTURE

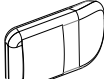
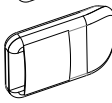
SWING AWAY - Lateral support
 Not available for backrest Physio AIR carbon shell
 Fixing and adjustment hardware complete with protection sleeve
 Alluminum lateral with padded, breathable upholstery.

	<input type="radio"/> Large (18x12)	05647	109.80
	<input type="radio"/> Small (14x9)	05643	109.80
	<input type="radio"/> Lateral support extension	Quantity (number pcs).....	
		10271	41.40
	<input type="radio"/> Lateral support extension	Quantity (number pcs).....	
	<input type="radio"/> Small (14x9)	05642	109.80
	<input type="radio"/> Large (18x12)	05646	109.80
<input type="radio"/> Headrest adjustable - Double ball mounting system Not available for backrest Physio AIR carbon shell	<input type="checkbox"/> Large (34x14)		05648
	<input type="checkbox"/> Small (28x14)		151.20

Permobil Limited Unit 7, Polaris Centre, 41 Brownfields, Welwyn Garden City, Herts, AL7 1AN United Kingdom - Phone: +44 1484 722888

customer_support_uk@permobil.com - https://www.permobil.com/en-gb

Send this page only if any optional have been chosen	
<input checked="" type="radio"/> standard	(supplied if no requests are indicated)
<input type="checkbox"/> on request	(without extra charge)
<input type="radio"/> optional	(cost to be added at the basic price)