

Date

User name

Responsible

Company stamp

Folding frame wheelchair

£ 995,00

Retail price - VAT not included

Wheelchair measures	
Seat width (LS)	<input type="checkbox"/> 33 <input type="checkbox"/> 36 <input type="checkbox"/> 39 <input type="checkbox"/> 42 <input type="checkbox"/> 45 <input type="checkbox"/> 48
Seat depth (PS)	<input type="checkbox"/> 35 <input type="checkbox"/> 37,5 <input type="checkbox"/> 40 <input type="checkbox"/> 42,5 <input type="checkbox"/> 45 <input type="checkbox"/> 47,5
Footplate distance (DP)	(Real distance between seat and footplate) IMPORTANT NOTICE! From the footplate to the floor minimum 4cm.!! (Minimum Front height = DP + 4cm.)
Setting	☆ Standard <input type="checkbox"/> Prudential <input type="checkbox"/> Active <input type="checkbox"/> Extreme
Backrest Height (TS)	Std.Value 36(min 30-max 54)
Crossbrace (black)	☆ Single <input type="checkbox"/> Double(Not seat width 33-36)
Front height (STD 49) - Rear height (STD 44)	

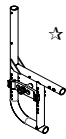
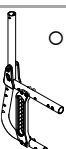
Rear frame	
Aluminium frame	<input checked="" type="checkbox"/> Aluminium standard frame - Same colour of front frame  <p>The real seat depth, from the front part of the seat cloth to the backrest tube will be 1 cm more than the declared one.</p> <p>camber ☆ 0° <input type="checkbox"/> 1,5° <input type="checkbox"/> 3°</p>
	<input type="checkbox"/> Aluminium frame DYNAMIC 2.0 - (COLOUR: BLACK) 09955 178.00  <p>The real seat depth, from the front part of the seat cloth to the backrest tube will be 1,5 cm more than the declared one. With rake adjustable backrest (±9°) Exclude the installation of : Brake handles for companion (Drum Brake)</p> <p>camber ☆ 0° <input type="checkbox"/> 1,5° <input type="checkbox"/> 2° <input type="checkbox"/> 4°</p>
Titanium frame TMAX	

Front frame	
<input type="checkbox"/> Short frame - Ideal with Seat depth (PS) 35 - 37,5 <input type="checkbox"/> Medium frame - Ideal with Seat depth (PS) 40 - 42,5 <input type="checkbox"/> Long frame - Ideal with Seat depth (PS) 45 - 47,5	Frame Angle <input checked="" type="checkbox"/> 110°  <input type="checkbox"/> 100° 

Frame colour (aluminium)	
<input checked="" type="checkbox"/> Opaque black <input type="checkbox"/> Bright silver <input type="checkbox"/> Bright fuchsia	<input type="checkbox"/> Polished black (Available until April 2020) <input type="checkbox"/> Bright anthracite <input type="checkbox"/> Bright orange <input type="checkbox"/> Bright blue <input type="checkbox"/> Bright lime <input type="checkbox"/> Bright blue china <input type="checkbox"/> Pearl white <input type="checkbox"/> Bright red





Backrest
☆ Adjustable velcro straps and padded transpiring upholstery





Handle tube	
☆ Tubes with standard handle <input type="checkbox"/> Folding handles	 02958 143.00



Colour set: Rear wheels and forks - To be matched only with: Rear wheels Ultra-light Progeo - Standard!																	
☆ Polished black	22" 24" 25" 26"																
<input type="checkbox"/> Bright silver	22" 24"																
<input type="checkbox"/> Bright anthracite	24"																
<input type="checkbox"/> Bright orange	22" 24"																
<input type="checkbox"/> Bright fuchsia	22" 24"																
<input type="checkbox"/> Bright blue	22" 24"																
<input type="checkbox"/> Bright red	22" 24"																
<input type="checkbox"/> Bright lime	22" 24"																
<input type="checkbox"/> Pearl white	22" 24"																
	<table border="0"> <tr><td>00833</td><td>71.00</td></tr> <tr><td>00833</td><td>71.00</td></tr> <tr><td>00833</td><td>71.00</td></tr> <tr><td>00833</td><td>71.00</td></tr> <tr><td>00833</td><td>71.00</td></tr> <tr><td>00833</td><td>71.00</td></tr> <tr><td>00833</td><td>71.00</td></tr> <tr><td>00833</td><td>71.00</td></tr> </table>	00833	71.00	00833	71.00	00833	71.00	00833	71.00	00833	71.00	00833	71.00	00833	71.00	00833	71.00
00833	71.00																
00833	71.00																
00833	71.00																
00833	71.00																
00833	71.00																
00833	71.00																
00833	71.00																
00833	71.00																

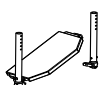
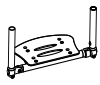

Permobil Limited

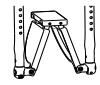
customer_support_uk@permobil.com - https://www.permobil.com/en-gb

Wheel locks		
<input checked="" type="checkbox"/> Bent lever push to lock		
<input type="checkbox"/> Straight lever push to lock		
<input type="checkbox"/> Straight lever pull to lock		
<input type="checkbox"/> Sport brake		06428 71.00
<input type="checkbox"/> Brake with extension lever push to lock		01949 35.00
<input type="checkbox"/> Brake with extension lever pull to lock		03372 35.00

Footplate - See reference tables N°3		
<input checked="" type="checkbox"/> Plastic footrest, rake adjustable (Minimum footplate distance 33cm.)	<input checked="" type="checkbox"/> 2/3 Internal <input type="checkbox"/> 2/3 External	 11525 no list
<input type="checkbox"/> Automatic Closure footplate , rake and depth adjustable (Minimum footplate distance 30cm.)	<input type="checkbox"/> Internal <input checked="" type="checkbox"/> 2/3 Internal <input type="checkbox"/> External	 11526 no list
<input type="checkbox"/> Minimum footplate distance 25cm. Available only with Multi-function and rotative system - 03945 107,00		
<input type="checkbox"/> One piece footplate - Flip-up! rake and depth adjustable (Minimum footplate distance 30cm.)	<input type="checkbox"/> Internal <input checked="" type="checkbox"/> 2/3 Internal <input type="checkbox"/> External	 11527 no list
<input type="checkbox"/> Minimum footplate distance 25cm. Available only with Multi-function and rotative system - 03945 107,00		
<input type="checkbox"/> One piece aluminium footplate - Flip-up! rake and depth adjustable (Minimum footplate distance 30cm.)	<input type="checkbox"/> Internal <input checked="" type="checkbox"/> 2/3 Internal <input type="checkbox"/> 2/3 External <input type="checkbox"/> External	 11528 no list
<input type="checkbox"/> One piece Carbon fibre footplate rake adjustable, swing away, flip-up. (Minimum footplate distance 30cm.)	<input checked="" type="checkbox"/> Internal <input type="checkbox"/> External	 03291 155.00
<input type="checkbox"/> Footplate COMPACT, automatic Closure, rake and depth adjustable Minimum footplate distance 35cm.	<input checked="" type="checkbox"/> Internal <input type="checkbox"/> External	 09957 143.00

Mudguard		
Mudguard - FIXED		
<input checked="" type="checkbox"/> ABS mudguard		03946 178.00
<input type="checkbox"/> ABS Straight sideguard		08918 178.00
<input type="checkbox"/> Carbon fibre mudguard		
<input type="checkbox"/> Carbon fibre Straight sideguard		
Mudguard - REMOVABLE		
<input type="checkbox"/> Removable ABS mudguard		08921 71.00
<input type="checkbox"/> Removable ABS fibre straight sideguard		08921 71.00
<input type="checkbox"/> Removable carbon fibre mudguard		08919 246.00
<input type="checkbox"/> Removable Carbon fibre straight sideguard		08920 246.00







Armrests		
<input type="checkbox"/> Tubular armrests	(Swing away, removable and height adjustable armrest) <input type="checkbox"/> Standard Support (Not with frame Dynamic) <input type="checkbox"/> Steel support with safety locking system	 04828 100.00 00694 143.00
Removable armrest with ABS mudguard		
<input type="checkbox"/> Desk armrests PROGEO	(Removable and height adjustable) Not available with Frame Dynamic 2.0 + camber 4°	 09956 127.00
<input type="checkbox"/> Removable armrest with ABS straight sideguard		 08881 127.00
<input type="checkbox"/> Removable armrest with carbon-fiber straight sideguard		08882 256.00

Permobil Limited

customer_support_uk@permobil.com - https://www.permobil.com/en-gb



Order Form - Progeo EXELLE

Accessories			
<input type="checkbox"/>	Pad for front frame protectors		07058 29.00
<input type="checkbox"/>	Backrest-seat connection cloth		10241 10.00
<input type="checkbox"/>	Removable storage bag (with quick coupling)		09811 71.00
Optional 1			
<input type="checkbox"/>	Transit wheels		00836 84.00
<input type="checkbox"/>	Anti-tipper with rapid hookup	(inside rotation to reduce the encumbrance) <input type="checkbox"/> Right <input type="checkbox"/> Left	 00023 71.00 00024 71.00
<input type="checkbox"/>	Tipping aid	<input type="checkbox"/> Right <input type="checkbox"/> Left	 00025 60.00 01046 60.00
<input type="checkbox"/>	Crutches support	<input type="checkbox"/> Right <input type="checkbox"/> Left	 00838 42.00 00837 42.00
Optional 2			
<input type="checkbox"/>	Tetraclip	(Quick release axle for quadriplegic)	03947 100.00
<input type="checkbox"/>	Rear wheels plate extension	(Not with frame Dynamic 2.0)	01950 100.00
<input type="checkbox"/>	Handybike adaptor	(Not with frame Dynamic 2.0)	 00506 42.00
<input type="checkbox"/>	Push handles for companion	(Removable and height adjustable)	 01048 107.00
<input type="checkbox"/>	Harness		04103 71.00
<input type="checkbox"/>	Safety pelvic belt		03972 35.00
<input type="checkbox"/>	Tray table (removable)		00508 155.00
<input type="checkbox"/>	Lumbar support	(to insert in the backrest upholstery)	00013 23.00
<input type="checkbox"/>	Super Head rest	(Folding with the wheelchair)	 04049 256.00
<input type="checkbox"/>	Swing away lateral support	<input type="checkbox"/> Right <input type="checkbox"/> Left	 02097 143.00 02098 143.00
	Not available with Posture backrest PHYSIO		
<input type="checkbox"/>	Spoke guards Black	(22"-24")	01043 84.00
<input type="checkbox"/>	Spoke guards Transparent	(22"-24")	00835 50.00
<input type="checkbox"/>	Spoke guards Progeo design	(22"-24")	00019 100.00
<input type="checkbox"/>	Spoke guards Dragon	(22"-24")	02106 100.00
Additional Kit			
<input type="checkbox"/>	24" Off-road rear wheels	Off-Road tyre - aluminium handrim (black colour)	03378 282.00
<input type="checkbox"/>	24" FAT rear wheels	FAT tyre 3" - aluminium handrim (black colour)	09357 496.00

Permobil Limited

customer_support_uk@permobil.com - https://www.permobil.com/en-gb

permobil

Order Form - Progeo EXELLE







Date	Order	User name	Address
------------	-------------	-----------------	---------------

PHYSIO - Posture backrest - Std. Backrest upholstery not provided

Removable with quick release

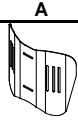

Suitable for tubes with diameter 18-26mm
 Depth adjustment (4cm)
 Angle adjustment (±18°)

- AIR** Carbon shell
 not available for seat width 48

BACKREST HEIGHT	28	34	40			
Shell's shape 	Lateral retaining wing A=high - R=regular					
	A	R	A	R	A	R
						
	<input type="checkbox"/>	<input type="checkbox"/>	<input type="checkbox"/>	<input type="checkbox"/>	<input type="checkbox"/>	<input type="checkbox"/>

593.00

- POSTURE** Aluminum shell

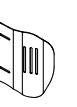
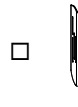
BACKREST HEIGHT	34	40	52
Shell's shape 	Lateral retaining wing B=regular		
	R	R	R
			
	<input type="checkbox"/>	<input type="checkbox"/>	<input type="checkbox"/>

574.00

Configuration DEEP with side support PAD (height adjustable)

- Alluminum lateral with padded, breathable upholstery.



Small (h 13cm)



- Right 10272
- Left 10272

16.00
16.00

Large (h 20cm)



- Right 10273
- Left 10273

23.00
23.00

SWING AWAY - Lateral support

Fixing and adjustment hardware complete with protection sleeve
 Alluminum lateral with padded, breathable upholstery.

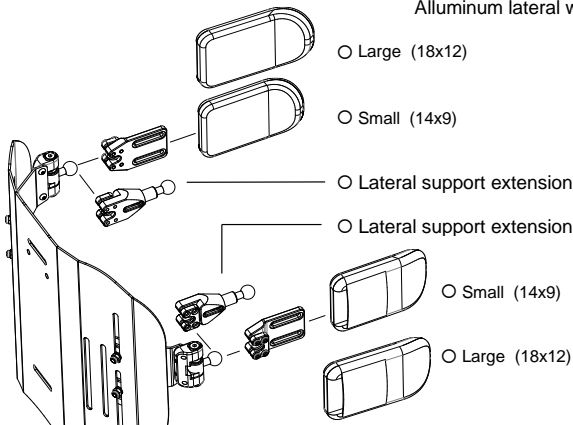

- Large (18x12)
- Small (14x9)
- Lateral support extension
- Lateral support extension
- Small (14x9)
- Large (18x12)

05647 104.00
 05643 104.00
 Quantity (number pcs)..... 10271 39.00
 Quantity (number pcs).....
 05642 104.00
 05646 104.00

- Headrest adjustable - Double ball mounting system
 Available only with backrest Physio
 Not available for backrest Physio AIR carbon shell

- Large (34x14)
- Small (28x14)



05648 143.00

Permobil Limited

customer_support_uk@permobil.com - https://www.permobil.com/en-gb

permobil

Order Form - Progeo EXELLE

Date Order User name Address

.....

Note

Wheelchair : Progeo EXELLE - Rev. 2022.4	Prices - VAT excluded to be added to the price list	Send this page only if any optional have been chosen <input checked="" type="checkbox"/> standard (supplied if no requests are indicated) <input type="checkbox"/> on request (without extra charge) <input type="checkbox"/> optional (cost to be added at the basic price)
--	--	---



Enclosure to wheelchair order form - Progeo EXELLE

REFERENCE TABLES

1	Front height
With closed frame (95°) max 5" caster	
Casters	Front height

2	Rear height			
Rear frame		Rear wheels		
Straight	22"	24"	25"	26"

	min.	max
3"	41	52
4"	42	53
5"	44	54
6"	48	55
7"	49	56

The size of the fork will be defined only by Progeo in accordance with wheelchair final configuration.

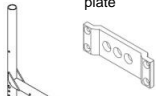
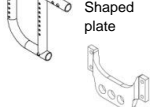
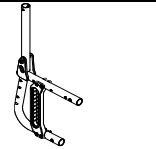
STANDARD		min. 37 max 45	min. 39 max 47	min. 40 max 48	min 41 max 49
		min. 36 max 49	min. 38 max 51	min. 39 max 52	min. 40 max 53
DYNAMIC 2.0		min. 36 max 49	min. 38 max 51	min. 39 max 52	min. 40 max 53

3	Footplate option	Footplate distance	
		Frame Angle 110°	Frame Angle 100°
	Plastic footrest	min. 33	min. 31
	Automatic Closure footplate	min. 30	min. 28
	Automatic Closure footplate , with multifunction rotative system	min. 25	min. 23
	One piece footplate - Flip-up!	min. 30	min. 28
	One piece footplate - Flip-up! , with multifunction rotative system	min. 25	min. 23
	One piece aluminium footplate - Flip-up!	min. 30	min. 28
	One piece Carbon fibre footplate	min. 30	min. 28

Calculated with the best configuration and with the footplates positioned on inside.

IMPORTANT NOTICE! From the footplate to the floor minimum 4cm.!! (Minimum Front height = DP + 4cm.)

4	Rear wheels	
	Model	Features
	22" Ultra-light Progeo - Standard!	(not available in anthracite color)
	24" Ultra-light Progeo - Standard!	(available for all colours)
	24" ULTRA-LIGHT PROGEO KEY SPORT	(silver hub, black rim and 16 spokes)
	24" Ultra-light "Spinergy LX"	(silver hub, black rim and spokes)
	24" Ultra-light "Spinergy LXL"	(black hub and rim, 18 white spokes) - (black hub, rim and 18 spokes)
	24" Ultra-light "Spinergy Flex rim"	(silver hub, black rim and spokes) - (integrated aluminium/rubber handrim - encumbrance reduction up to 3cm. - all tyre)
	24" Off-road	(colour: black) - (aluminium handrim - tyre Off-road)
	25" Ultra-light "Spinergy LX"	(silver hub, black rim and spokes)
	25" Ultra-light "Spinergy LXL"	(black hub and rim, 18 white spokes)
	26" Progeo - Standard!	(colour: black)
	26" Ultra-light "Spinergy LX"	(silver hub, black rim and 18 spokes)

Wheelchair : Progeo EXELLE - Rev. 2022.4