

Order form

Custom Inception cushion

Pricing in Canadian dollars

For best results, do not fill out in your browser. Interactive form should be completed using Adobe Reader after saving to your local drive. Then email to sales.ca@permobil.com or print and fax to 877.636.8944.

DO NOT SEND PROTECTED HEALTH INFORMATION. IT IS NOT NEEDED TO MAKE THE PRODUCT YOU ARE REQUESTING.

Customer information

Date: _____
 Company name/ACCT #: _____
 Client name: _____
 Client weight: _____
 Client height: _____
 Client reference: _____

P.O. number: _____
 Requested by: _____
 Phone: _____ Fax: _____
 Email: _____
 Ship to: _____

Additional information:

W/C manufacturer: _____
 Model #: _____ Serial #: _____

1 Size, cover, & shape

1.1 Size

Custom part number:
C-C- W D

Please fill in the above with desired dimensions
 or select a size in the chart below.
 Example part number: **C-C-15W18D**

*If desired size is not listed below, a 60%
 upcharge will be applied for materials and
 Customer Support approval is required.

Base MSRP by size

Depth	22"	\$815.00																\$1,560.00
	21"																	
	20"																	
	19"																	
	18"																	
	17"																	
	16"																	
	15"																	
	14"	\$620.00																
	13"																	
12"																		
11"																		
10"																		
Width																		

Depth	22"	C-C-10W22D	C-C-11W22D	C-C-12W22D	C-C-13W22D	C-C-14W22D	C-C-15W22D	C-C-16W22D	C-C-17W22D	C-C-18W22D	C-C-19W22D	C-C-20W22D	C-C-21W22D	C-C-22W22D	C-C-23W22D	C-C-24W22D	C-C-25W22D	C-C-26W22D	C-C-27W22D	C-C-28W22D
	21"	C-C-10W21D	C-C-11W21D	C-C-12W21D	C-C-13W21D	C-C-14W21D	C-C-15W21D	C-C-16W21D	C-C-17W21D	C-C-18W21D	C-C-19W21D	C-C-20W21D	C-C-21W21D	C-C-22W21D	C-C-23W21D	C-C-24W21D	C-C-25W21D	C-C-26W21D	C-C-27W21D	C-C-28W21D
	20"	C-C-10W20D	C-C-11W20D	C-C-12W20D	C-C-13W20D	C-C-14W20D	C-C-15W20D	C-C-16W20D	C-C-17W20D	C-C-18W20D	C-C-19W20D	C-C-20W20D	C-C-21W20D	C-C-22W20D	C-C-23W20D	C-C-24W20D	C-C-25W20D	C-C-26W20D	C-C-27W20D	C-C-28W20D
	19"	C-C-10W19D	C-C-11W19D	C-C-12W19D	C-C-13W19D	C-C-14W19D	C-C-15W19D	C-C-16W19D	C-C-17W19D	C-C-18W19D	C-C-19W19D	C-C-20W19D	C-C-21W19D	C-C-22W19D	C-C-23W19D	C-C-24W19D	C-C-25W19D	C-C-26W19D	C-C-27W19D	C-C-28W19D
	18"	C-C-10W18D	C-C-11W18D	C-C-12W18D	C-C-13W18D	C-C-14W18D	C-C-15W18D	C-C-16W18D	C-C-17W18D	C-C-18W18D	C-C-19W18D	C-C-20W18D	C-C-21W18D	C-C-22W18D	C-C-23W18D	C-C-24W18D	C-C-25W18D	C-C-26W18D	C-C-27W18D	C-C-28W18D
	17"	C-C-10W17D	C-C-11W17D	C-C-12W17D	C-C-13W17D	C-C-14W17D	C-C-15W17D	C-C-16W17D	C-C-17W17D	C-C-18W17D	C-C-19W17D	C-C-20W17D	C-C-21W17D	C-C-22W17D	C-C-23W17D	C-C-24W17D	C-C-25W17D	C-C-26W17D	C-C-27W17D	C-C-28W17D
	16"	C-C-10W16D	C-C-11W16D	C-C-12W16D	C-C-13W16D	C-C-14W16D	C-C-15W16D	C-C-16W16D	C-C-17W16D	C-C-18W16D	C-C-19W16D	C-C-20W16D	C-C-21W16D	C-C-22W16D	C-C-23W16D	C-C-24W16D	C-C-25W16D	C-C-26W16D	C-C-27W16D	C-C-28W16D
	15"	C-C-10W15D	C-C-11W15D	C-C-12W15D	C-C-13W15D	C-C-14W15D	C-C-15W15D	C-C-16W15D	C-C-17W15D	C-C-18W15D	C-C-19W15D	C-C-20W15D	C-C-21W15D	C-C-22W15D	C-C-23W15D	C-C-24W15D	C-C-25W15D	C-C-26W15D	C-C-27W15D	C-C-28W15D
	14"	C-C-10W14D	C-C-11W14D	C-C-12W14D	C-C-13W14D	C-C-14W14D	C-C-15W14D	C-C-16W14D	C-C-17W14D	C-C-18W14D	C-C-19W14D	C-C-20W14D	C-C-21W14D	C-C-22W14D	C-C-23W14D	C-C-24W14D	C-C-25W14D	C-C-26W14D	C-C-27W14D	C-C-28W14D
	13"	C-C-10W13D	C-C-11W13D	C-C-12W13D	C-C-13W13D	C-C-14W13D	C-C-15W13D	C-C-16W13D	C-C-17W13D	C-C-18W13D	C-C-19W13D	C-C-20W13D	C-C-21W13D	C-C-22W13D	C-C-23W13D	C-C-24W13D	C-C-25W13D	C-C-26W13D	C-C-27W13D	C-C-28W13D
12"	C-C-10W12D	C-C-11W12D	C-C-12W12D	C-C-13W12D	C-C-14W12D	C-C-15W12D	C-C-16W12D	C-C-17W12D	C-C-18W12D	C-C-19W12D	C-C-20W12D	C-C-21W12D	C-C-22W12D	C-C-23W12D	C-C-24W12D	C-C-25W12D	C-C-26W12D	C-C-27W12D	C-C-28W12D	
11"	C-C-10W11D	C-C-11W11D	C-C-12W11D	C-C-13W11D	C-C-14W11D	C-C-15W11D	C-C-16W11D	C-C-17W11D	C-C-18W11D	C-C-19W11D	C-C-20W11D	C-C-21W11D	C-C-22W11D	C-C-23W11D	C-C-24W11D	C-C-25W11D	C-C-26W11D	C-C-27W11D	C-C-28W11D	
10"	C-C-10W10D	C-C-11W10D	C-C-12W10D	C-C-13W10D	C-C-14W10D	C-C-15W10D	C-C-16W10D	C-C-17W10D	C-C-18W10D	C-C-19W10D	C-C-20W10D	C-C-21W10D	C-C-22W10D	C-C-23W10D	C-C-24W10D	C-C-25W10D	C-C-26W10D	C-C-27W10D	C-C-28W10D	
Width																				

Order #: _____

1.2 Cover material options

MSRP Standard \$0.00 | w/GlideWear \$38.00



COMFORT-TEK®

A smooth, easily cleaned surface. The incontinence protection also aids in infection control.

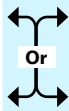

STRETCH-AIR®

Stretch-Air has comfortable stretch and heat dissipation.

GlideWear™

Shear reduction panel



Selected for shear reduction, micro-climate control and improved comfort. This fabric panel sits below the bony prominences for maximum skin protection.

COMFORT-TEK	
Standard (CD-COMFORT-TEK)	WITH GlideWear (CD-GW-COMFORT-TEK)
STRETCH-AIR	
Standard (CD-STRETCH-AIR)	WITH GlideWear (CD-GW-STRETCH-AIR)

1.3 Incontinence liner

MSRP \$130.00

Note: If a ROHO Air Insert is selected, Incontinence Liner will have a small opening for the valve hose.

Incontinence Liner (CD-INCON-LINER)

1.4 Extra cover

MSRP Standard \$135.00 | w/GlideWear \$145.00

COMFORT-TEK	
Standard (CD-X-COMFORT-TEK)	WITH GlideWear (CD-GW-X-COMFORT-TEK)
STRETCH-AIR	
Standard (CD-X-STRETCH-AIR)	WITH GlideWear (CD-GW-X-STRETCH-AIR)

2 Base specifications

Seat shape reference guide

Linear	Anti-thrust	Zero elevation contour	Anti-thrust contour
<ul style="list-style-type: none"> • Base Structure - Flat Bottom with ¼" Crosslink • Lower Layer - 1" HR Medium • Middle Layer - ½" HR Medium • Topper Layer - ½" Viscool Soft 	<p>Foam layers as listed in Linear, PLUS...</p> <ul style="list-style-type: none"> • Anti-Thrust - 1" H (15W and above) ½ seat depth or ½" H (14W or below) 	<p>Foam layers as listed in Linear, PLUS...</p> <ul style="list-style-type: none"> • Straight Adductors - 1 ½" H (15W and above) or 1" H (14W or below) • Abductor - 1 ½" H (15W and above) or 1" H (14W or below) 	<p>Foam layers as listed in Linear, PLUS...</p> <ul style="list-style-type: none"> • Anti-Thrust - 1" H (15W and above) ½ seat depth or ½" H (14W or below) • Straight Adductors - 1 ½" H (15W and above) or 1" H (14W or below) • Abductor - 1 ½" H (15W and above) or 1" H (14W or below)

Order #: _____

CD-INCEPTION-FORM REV071223

DO NOT SEND PROTECTED HEALTH INFORMATION. IT IS NOT NEEDED TO MAKE THE PRODUCT YOU ARE REQUESTING.

2.1 Bottom style

A.

Note: Only **one** bottom style may be selected. Flat Bottom is standard if an alternate style is not selected.

Flat MSRP \$0.00



Front view

Flat bottom (CD-FLAT-BOTTOM)

Round MSRP \$57.00



Front view

Round bottom (CD-ROUND-BOTTOM)

Note: A reverse wedge will add height to the rear of the seat support surface. Cannot be paired with ROHO Air Insert, only full wedges available with anti-thrust and ischial insert.

Wedge (MSRP notes in height selection)

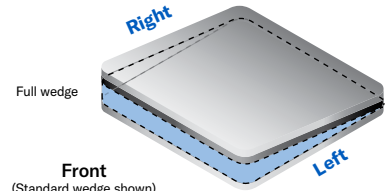

Full wedge

Front
(Standard wedge shown)

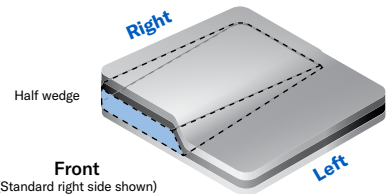

Half wedge

Front
(Standard right side shown)

Standard full wedge (CD-WEDGE-STANDARD)
Standard left side (CD-WEDGE-LEFT)
Standard right side (CD-WEDGE-RIGHT)
Reverse full wedge (CD-WEDGE-REV)
Reverse left side (CD-WEDGE-REV-LEFT)
Reverse right side (CD-WEDGE-REV-RIGHT)

B.

Note: Wedge is not a removable feature.

Wedge height MSRP \$57.00

Front Rear

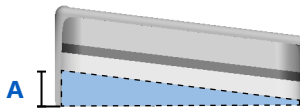

Side view
(Standard style shown)

A = 1" (CD-WEDGE-1)
A = 2" (CD-WEDGE-2)
A = 3" (CD-WEDGE-3)
A = Other _____ (CD-WEDGE-OTHER)

2.2 Anti-thrust MSRP \$0.00

Instructions: Choose one style and height (directly below your style choice) in subsection A. Anti-thrust will be 1/2 of the seat support depth unless otherwise noted in subsection B. **NOTE:** Depth dimension is determined before growth kit strips are applied. Cannot be paired with a ROHO Air Insert or a left or right wedge.

A.

Anti-thrust style & height

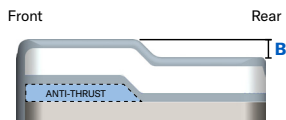

Side view

Standard anti-thrust (CD-AT-STANDARD)
Left side only (CD-AT-LEFT)
Right side only (CD-AT-RIGHT)

B = 1/2" (CD-AT-HEIGHT-0.5)
B = 1" (CD-AT-HEIGHT-1.0)
B = 1 1/2" (CD-AT-HEIGHT-1.5)
B = 2" (CD-AT-HEIGHT-2.0)
B = 2 1/2" (CD-AT-HEIGHT-2.5)
B = Other _____ (CD-AT-HEIGHT-OTHER)

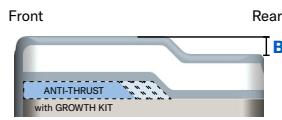

Side view

Standard anti-thrust with growth kit (CD-AT-STND-GROWTH-KIT)

Anti-Thrust with (3) 1" strips included for growing the Anti-Thrust depth. Top layer foam is not glued in the seat well allowing access to the 1" pieces.

B = 1/2" (CD-AT-GK-HEIGHT-0.5)
B = 1" (CD-AT-GK-HEIGHT-1.0)
B = 1 1/2" (CD-AT-GK-HEIGHT-1.5)
B = 2" (CD-AT-GK-HEIGHT-2.0)
B = 2 1/2" (CD-AT-GK-HEIGHT-2.5)
B = Other _____ (CD-AT-GK-HEIGHT-OTHER)

B.

Anti-thrust depth

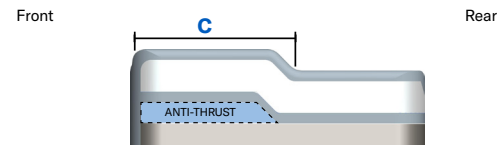

Side view

C = 4" (CD-AT-DEPTH-4)
C = 5" (CD-AT-DEPTH-5)
C = 6" (CD-AT-DEPTH-6)
C = 7" (CD-AT-DEPTH-7)
C = 8" (CD-AT-DEPTH-8)
C = 9" (CD-AT-DEPTH-9)
C = 10" (CD-AT-DEPTH-10)

C = 11" (CD-AT-DEPTH-11)
C = 12" (CD-AT-DEPTH-12)
C = 13" (CD-AT-DEPTH-13)
C = 14" (CD-AT-DEPTH-14)
C = 15" (CD-AT-DEPTH-15)
C = 16" (CD-AT-DEPTH-16)
C = Other _____ (CD-AT-DEPTH-OTHER)

Order #: _____

CD-INCEPTION-FORM REV071223

3 of 10

DO NOT SEND PROTECTED HEALTH INFORMATION. IT IS NOT NEEDED TO MAKE THE PRODUCT YOU ARE REQUESTING.

3 Foam layers

Note: If ordering a ROHO Insert, please see Section 4.1 for foam layer restrictions.

3.1 Structural layer

MSRP \$0.00

None	CD-FOAM-STRUCTURAL-NONE
1/4" Crosslink	CD-FOAM-STRUCTURAL-0.25

Foam recommendations by user weight:

Pediatric or User <100 lb (45 kg)		FIRM	HRM	HRS	VIS-M	VIS-S	VIS-XS	VIS-XXS
Lower layer	Minimum 1 1/2" (lower and mid layer combined)	●	○		●			
Mid layer			○		●	●		
Topper layer	Minimum 1/4"			●		●	○	

Standard user 100 to 350 lb (45-158 kg)		FIRM	HRM	HRS	VIS-M	VIS-S	VIS-XS	VIS-XXS
Lower layer	Minimum 2 1/2" (lower and mid layer combined)	●	○		●			
Mid layer			○		●	●		
Topper layer	Minimum 1/4"			●		●	○	

Bariatric user >350 lb (158 kg)		FIRM	HRM	HRS	VIS-M	VIS-S	VIS-XS	VIS-XXS
Lower layer	Minimum 3 1/2" (lower and mid layer combined)	●	○		●			
Mid layer			○		●	●		
Topper layer	Minimum 1/2"		○	●	●	●	○	

3.2 Lower layers

MSRP HR \$0.00 | Visco \$225.00 each | Crosslink Firm \$47.00 each

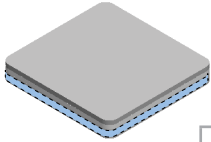

Note: We do not recommend a MEDIUM foam on top of a SOFT foam. "Other" Visco foam layer thicknesses must be in 1/2" increments. *Additional foam layers, if chosen, will be placed on top of the original layer.

Lower layer thickness

	1/4"	1/2"	3/4"	1"	1 1/4"	Other 3" Max
HR Medium	CD-LOW-HRM-0.25	CD-LOW-HRM-0.50	CD-LOW-HRM-0.75	CD-LOW-HRM-1.00	CD-LOW-HRM-1.25	CD-LOW-HRM-OTHER
Visco Medium		CD-LOW-VIS-M-0.50		CD-LOW-VIS-M-1.00		CD-ADD-LOW-VIS-M-OTHER
Crosslink Firm		CD-LOW-FRM-0.50		CD-LOW-FRM-1.00		

*Optional - Additional lower layer thickness

	1/4"	1/2"	3/4"	1"	1 1/4"	OTHER 3" Max
	CD-ADD-LOW-HRM-0.25	CD-ADD-LOW-HRM-0.50	CD-ADD-LOW-HRM-0.75	CD-ADD-LOW-HRM-1.00	CD-ADD-LOW-HRM-1.25	CD-ADD-LOW-HRM-OTHER
		CD-ADD-LOW-VIS-M-0.50		CD-ADD-LOW-VIS-M-1.00		CD-ADD-LOW-VIS-M-OTHER
		CD-ADD-LOW-FRM-0.50		CD-ADD-LOW-FRM-1.00		

**1/4" lower layer is only to be used in conjunction with 1/4" structural layer.

3.3 Mid layers

MSRP HR \$0.00 | Visco \$225.00 each

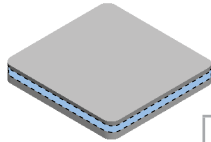

Note: A minimum thickness mid layer must be selected if a QuadraGel insert, ischial gel insert, or ischial memory foam insert is chosen. See section 4.1 for specific details. A recess is cut from the mid layer, so if a recess is selected in section 5.4, the mid layer may need to be thicker to allow for enough support in all areas.

Mid layer thickness

	1/4"	1/2"	3/4"	1"	1 1/4"	Other 2" Max
HR Medium	CD-MID-HRM-0.25	CD-MID-HRM-0.50	CD-MID-HRM-0.75	CD-MID-HRM-1.00	CD-MID-HRM-1.25	CD-MID-HRM-OTHER
HR Soft	CD-MID-HRS-0.25	CD-MID-HRS-0.50	CD-MID-HRS-0.75	CD-MID-HRS-1.00	CD-MID-HRS-1.25	CD-MID-HRS-OTHER
Visco Medium		CD-MID-VIS-M-0.50		CD-MID-VIS-M-1.00		CD-MID-VIS-M-OTHER
Visco Soft		CD-MID-VIS-S-0.50		CD-MID-VIS-S-1.00		CD-MID-VIS-S-OTHER
Visco X-Soft		CD-MID-VIS-XS-0.50		CD-MID-VIS-XS-1.00		CD-MID-VIS-XS-OTHER

*Optional - Additional mid layer thickness

	1/4"	1/2"	3/4"	1"	1 1/4"	Other 2" Max
	CD-Add-Mid-HRM-0.25	CD-Add-Mid-HRM-0.50	CD-Add-Mid-HRM-0.75	CD-Add-Mid-HRM-1.00	CD-Add-Mid-HRM-1.25	CD-Add-Mid-HRM-OTHER
	CD-Add-Mid-HRS-0.25	CD-Add-Mid-HRS-0.50	CD-Add-Mid-HRS-0.75	CD-Add-Mid-HRS-1.00	CD-Add-Mid-HRS-1.25	CD-Add-Mid-HRS-OTHER
		CD-Add-Mid-VIS-M-0.50		CD-Add-Mid-VIS-M-1.00		CD-Add-Mid-VIS-M-OTHER
		CD-Add-Mid-VIS-S-0.50		CD-Add-Mid-VIS-S-1.00		CD-Add-Mid-VIS-S-OTHER
		CD-Add-Mid-VIS-XS-0.50		CD-Add-Mid-VIS-XS-1.00		CD-Add-Mid-VIS-XS-OTHER

3.4 Topper layers

MSRP HR \$0.00 | Visco \$225.00 each

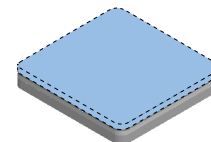

Note: A minimum 1/4" thick topper layer must be selected here if a QuadraGel insert, ischial gel insert, or ischial memory foam insert was chosen in section 4.1.

Topper layer thickness

	1/4"	1/2"	3/4"	1"	1 1/4"	Other 2" Max
HR Medium	CD-TOP-HRM-0.25	CD-TOP-HRM-0.50	CD-TOP-HRM-0.75	CD-TOP-HRM-1.00	CD-TOP-HRM-1.25	CD-TOP-HRM-OTHER
HR Soft	CD-TOP-HRS-0.25	CD-TOP-HRS-0.50	CD-TOP-HRS-0.75	CD-TOP-HRS-1.00	CD-TOP-HRS-1.25	CD-TOP-HRS-OTHER
Visco Medium		CD-TOP-VIS-M-0.50		CD-TOP-VIS-M-1.00		CD-TOP-VIS-M-OTHER
Visco Soft		CD-TOP-VIS-S-0.50		CD-TOP-VIS-S-1.00		CD-TOP-VIS-S-OTHER
Visco X-Soft		CD-TOP-VIS-XS-0.50		CD-TOP-VIS-XS-1.00		CD-TOP-VIS-XS-OTHER
Visco XX-Soft		CD-TOP-VIS-XXS-0.50		CD-TOP-VIS-XXS-1.00		CD-TOP-VIS-XXS-OTHER

*Optional - Additional topper layer thickness

	1/4"	1/2"	3/4"	1"	1 1/4"	Other 2" Max
	CD-ADD-TOP-HRM-0.25	CD-ADD-TOP-HRM-0.50	CD-ADD-TOP-HRM-0.75	CD-ADD-TOP-HRM-1.00	CD-ADD-TOP-HRM-1.25	CD-ADD-TOP-HRM-OTHER
	CD-ADD-TOP-HRS-0.25	CD-ADD-TOP-HRS-0.50	CD-ADD-TOP-HRS-0.75	CD-ADD-TOP-HRS-1.00	CD-ADD-TOP-HRS-1.25	CD-ADD-TOP-HRS-OTHER
		CD-ADD-TOP-VIS-M-0.50		CD-ADD-TOP-VIS-M-1.00		CD-ADD-TOP-VIS-M-OTHER
		CD-ADD-TOP-VIS-S-0.50		CD-ADD-TOP-VIS-S-1.00		CD-ADD-TOP-VIS-S-OTHER
		CD-ADD-TOP-VIS-XS-0.50		CD-ADD-TOP-VIS-XS-1.00		CD-ADD-TOP-VIS-XS-OTHER
		CD-ADD-TOP-VIS-XXS-0.50		CD-ADD-TOP-VIS-XXS-1.00		CD-ADD-TOP-VIS-XXS-OTHER

Order #: _____

CD-INCEPTION-FORM REV071223

4 of 10

DO NOT SEND PROTECTED HEALTH INFORMATION. IT IS NOT NEEDED TO MAKE THE PRODUCT YOU ARE REQUESTING.

4 Ischial modifications

4.1 Ischial modifications

Note: Ischial inserts are recessed into the mid layer of foam and sit beneath the topper layer. Only **one** insert may be selected. Additional ischial modification options on next page.

Note: A minimum of 3/4" mid layer is required for this insert in section 3.3. Cannot be paired with a ROHO Air Insert or left/right wedge.

Note: A minimum of 1/2" mid layer is required for this insert in section 3.3. Cannot be paired with a ROHO Air Insert or left/right wedge.

Note: A mid layer of foam must be selected in section 3.3 and, at a minimum, match the insert thickness selected. Cannot be paired with a ROHO Air Insert. Foam type cannot match foam type selected for mid layer in 3.3.

QuadraGel® insert
MSRP \$145.00

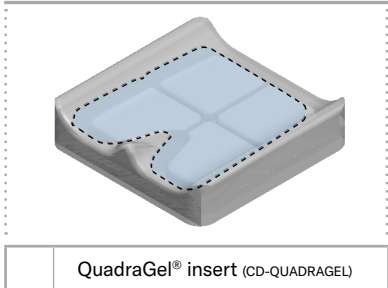

QuadraGel® insert (CD-QUADRAGEL)

Ischial gel insert
MSRP \$115.00

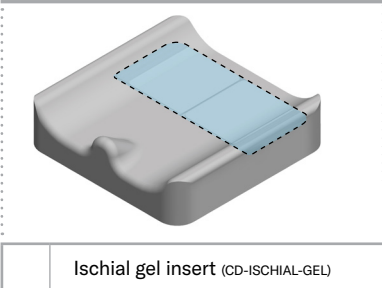

Ischial gel insert (CD-ISCHIAL-GEL)

Ischial Visco memory foam insert
MSRP \$100.00

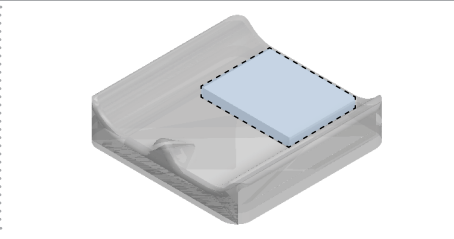

1" thick soft Visco memory foam insert (CD-ISCHIAL-SOFT-1.0)
1" thick x-soft Visco memory foam insert (CD-ISCHIAL-XSOFT-1.0)
1" thick xx-soft Visco memory foam insert (CD-ISCHIAL-XXSOFT-1.0)
1/2" thick soft Visco memory foam insert (CD-ISCHIAL-SOFT-0.5)
1/2" thick x-soft Visco memory foam insert (CD-ISCHIAL-XSOFT-0.5)
1/2" thick xx-soft Visco memory foam insert (CD-ISCHIAL-XXSOFT-0.5)

Note: ROHO Air insert includes hand pump and repair kit.

ROHO® Air insert
MSRP \$505.00

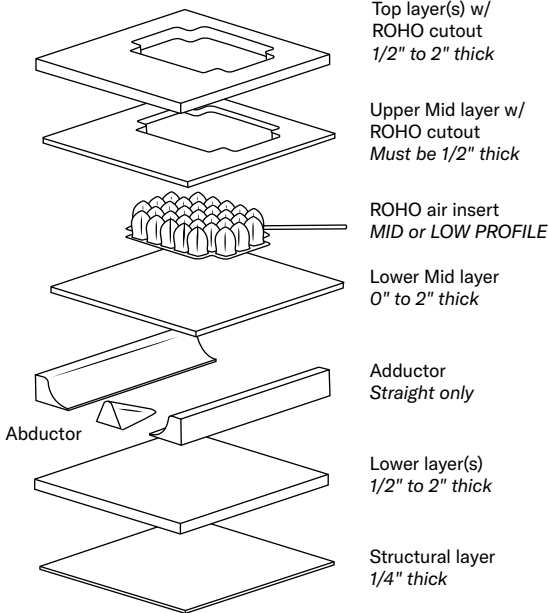
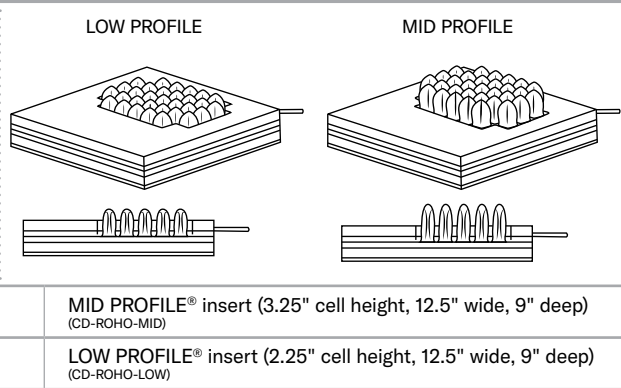

Size restrictions:

- Minimum width: 16W
- Minimum depth: 16D

Foam restrictions:

Top layer:

- No HR/Visco Medium foams

Middle layer:

- Only HR/Visco Medium foams
- Top mid layer must be 1/2" thick

ROHO Insert cannot be paired with:

- Wedge
- Anti-thrust
- Gel insert or Ischial memory foam insert
- Recess
- Coccyx cut out
- Tapered adductors

Can be paired with Straight adductors if seat is 18W or greater.

5 Custom specs & geometry

5.1 Adduction

Instructions: Select an adductor height for each side in subsection A, select an adductor style and material for each side in subsection B. If no adduction is needed, choose "none" in subsection A.

If a height is selected but not a style, a full-length, straight, adductor will be applied.

Note: Custom adductor requests should be noted in the "Additional information" section 7.1.

Note: In subsection B, one adductor style may be selected for each side of the seat support. Front or rear only adductor will be 1/2 the seat support depth or match an anti-thrust depth. Tapered adductor cannot be paired with ROHO Air Insert. Straight adductor CAN be paired with a ROHO Air Insert, but must have a seat width 18 wide or greater.

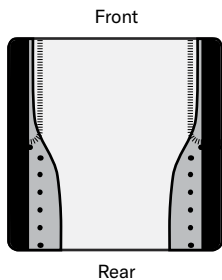

- Tapered adductor shape
- Straight adductor shape
- REAR ONLY adduction area
- FRONT ONLY adduction area

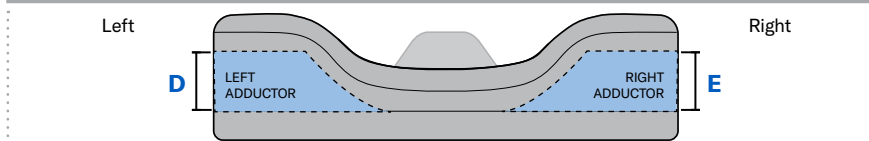

Rear view
MSRP None/HR Medium \$0.00 | Crosslink Firm \$47.00

A.		B.		C.	
D	Left adductor height	E	Right adductor height	No adductor	No adductor
	D = 1/2" (CD-LEFT-ADD-0.5)		E = 1/2" (CD-RIGHT-ADD-0.5)		
	D = 1" (CD-LEFT-ADD-1.0)		E = 1" (CD-RIGHT-ADD-1.0)		
	D = 1 1/2" (Standard) (CD-LEFT-ADD-1.5)		E = 1 1/2" (Standard) (CD-RIGHT-ADD-1.5)		
	D = 2" (CD-LEFT-ADD-2.0)		E = 2" (CD-RIGHT-ADD-2.0)		
	D = 2 1/2" (CD-LEFT-ADD-2.5)		E = 2 1/2" (CD-RIGHT-ADD-2.5)		
	D = Other _____ (CD-LEFT-ADD-OTHER)		E = Other _____ (CD-RIGHT-ADD-OTHER)		
B.		B.		C.	
	Left adductor style		Right adductor style		No adductor
	Tapered adductor, HR Medium (CD-LEFT-ADD-TAPERED)		Tapered adductor, HR Medium (CD-RIGHT-ADD-TAPERED)		
	Straight adductor, HR Medium (CD-LEFT-ADD-STRAIGHT)		Straight adductor, HR Medium (CD-RIGHT-ADD-STRAIGHT)		
	Rear only straight adductor, HR Medium (CD-LEFT-ADD-REAR-ONLY)		Rear only straight adductor, HR Medium (CD-RIGHT-ADD-REAR-ONLY)		
	Front only straight adductor, HR Medium (CD-LEFT-ADD-FRONT-ONLY)		Front only straight adductor, HR Medium (CD-RIGHT-ADD-FRONT-ONLY)		
	Tapered adductor, Crosslink Firm (CD-LEFT-ADD-TAPERED-FIRM)		Tapered adductor, Crosslink Firm (CD-RIGHT-ADD-TAPERED-FIRM)		
	Straight adductor, Crosslink Firm (CD-LEFT-ADD-STRAIGHT-FIRM)		Straight adductor, Crosslink Firm (CD-RIGHT-ADD-STRAIGHT-FIRM)		
	Rear only straight adductor, Crosslink Firm (CD-LEFT-ADD-REAR-ONLY-FIRM)		Rear only straight adductor, Crosslink Firm (CD-RIGHT-ADD-REAR-ONLY-FIRM)		
	Front only straight adductor, Crosslink Firm (CD-LEFT-ADD-FRONT-ONLY-FIRM)		Front only straight adductor, Crosslink Firm (CD-RIGHT-ADD-FRONT-ONLY-FIRM)		
	No adductor		No adductor		No adductor
	None (CD-LEFT-ADD-NONE)		None (CD-RIGHT-ADD-NONE)		None (CD-RIGHT-ADD-NONE)

5.2 Abduction

MSRP None/HR Medium \$0.00 | Crosslink Firm \$47.00

Instructions: Select an abductor height and an abductor material.
Note: Custom abductor requests should be noted in the "Additional information" section 9.1.

Abductor height and material

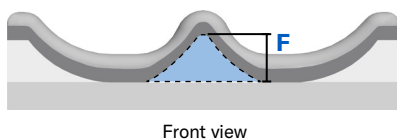

	None (CD-ABD-NONE)		F = 1/2", Crosslink Firm (CD-ABD-HEIGHT-0.5-FIRM)
	F = 1/2", HR Medium (CD-ABD-HEIGHT-0.5)		F = 1", Crosslink Firm (CD-ABD-HEIGHT-1.0-FIRM)
	F = 1", HR Medium (CD-ABD-HEIGHT-1.0)		F = 1 1/2", Crosslink Firm (CD-ABD-HEIGHT-1.5-FIRM)
	F = 1 1/2", HR Medium (CD-ABD-HEIGHT-1.5)		F = 2", Crosslink Firm (CD-ABD-HEIGHT-2.0-FIRM)
	F = 2", HR Medium (CD-ABD-HEIGHT-2.0)		F = 2 1/2", Crosslink Firm (CD-ABD-HEIGHT-2.5-FIRM)
	F = 2 1/2", HR Medium (CD-ABD-HEIGHT-2.5)		F = Other, Crosslink Firm _____ (CD-ABD-HEIGHT-OTHER-FIRM)
	F = Other, HR Medium _____ (CD-ABD-HEIGHT-OTHER)		

5.3 Coccyx cutout

MSRP \$0.00

Note: Coccyx cut out will be centered and cut in the lower layer of foam. If gel insert is selected, additional mid layer is required. Cannot be paired with ROHO Air Insert. Cannot be paired with a recess in section 5.5. Custom cut out requests should be noted in the "Additional information" section 9.1.

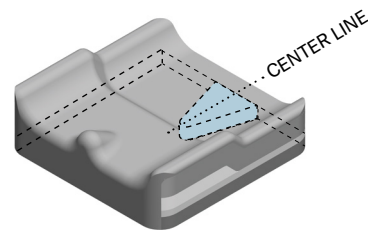

Coccyx Cut Out (CD-COCYX-CUT)

Order #: _____

CD-INCEPTION-FORM REV071223

6 of 10

DO NOT SEND PROTECTED HEALTH INFORMATION. IT IS NOT NEEDED TO MAKE THE PRODUCT YOU ARE REQUESTING.

5.4 Recess

MSRP \$255.00

Note: If a recess is selected, the mid layer foam thickness in section 3.3 must match the TOTAL amount of modifications selected in 4.1 and 5.2. Cannot be paired with ROHO Air Insert or coccyx cutout.

Rear quadrant recess

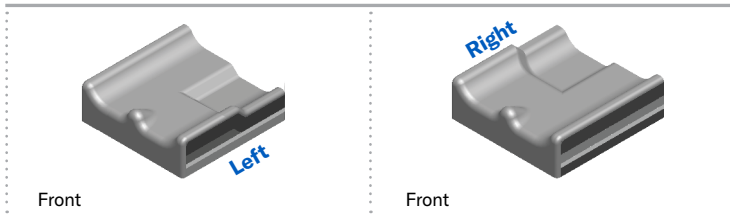

L	Left side	R	Right side
	1/4" H (CD-IR-LEFT-REAR-0.25)		1/4" H (CD-IR-RIGHT-REAR-0.25)
	1/2" H (CD-IR-LEFT-REAR-0.5)		1/2" H (CD-IR-RIGHT-REAR-0.5)
	3/4" H (CD-IR-LEFT-REAR-0.75)		3/4" H (CD-IR-RIGHT-REAR-0.75)
	1" H (CD-IR-LEFT-REAR-1.0)		1" H (CD-IR-RIGHT-REAR-1.0)
	1 1/4" H (CD-IR-LEFT-REAR-1.25)		1 1/4" H (CD-IR-RIGHT-REAR-1.25)
	Other _____ (CD-IR-LEFT-REAR-OTHER)		Other _____ (CD-IR-RIGHT-REAR-OTHER)

Full length recess

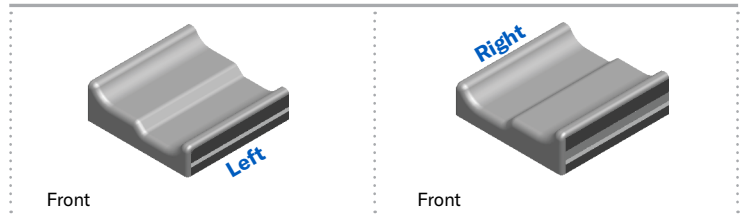

L	Left side	R	Right side
	1/4" H (CD-IR-LEFT-FULL-0.25)		1/4" H (CD-IR-RIGHT-FULL-0.25)
	1/2" H (CD-IR-LEFT-FULL-0.5)		1/2" H (CD-IR-RIGHT-FULL-0.5)
	3/4" H (CD-IR-LEFT-FULL-0.75)		3/4" H (CD-IR-RIGHT-FULL-0.75)
	1" H (CD-IR-LEFT-FULL-1.0)		1" H (CD-IR-RIGHT-FULL-1.0)
	1 1/4" H (CD-IR-LEFT-FULL-1.25)		1 1/4" H (CD-IR-RIGHT-FULL-1.25)
	Other _____ (CD-IR-LEFT-FULL-OTHER)		Other _____ (CD-IR-RIGHT-FULL-OTHER)

5.5 Hamstring relief

MSRP \$57.00

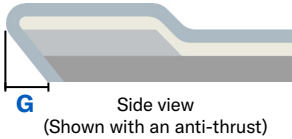

G Side view
(Shown with an anti-thrust)

Note: Choose one hamstring relief option. Left or right side relief will be half the width of the cushion. Custom requests should be noted in "Additional information" section 9.1.

Full width relief

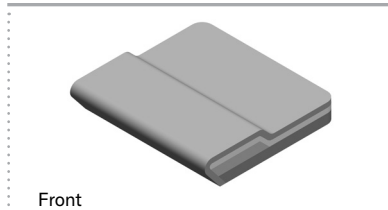

G = 1" D (CD-HAM-RELIEF-1)
G = 2" D (CD-HAM-RELIEF-2)
G = Other _____ (CD-HAM-RELIEF-OTHER)

Left side relief

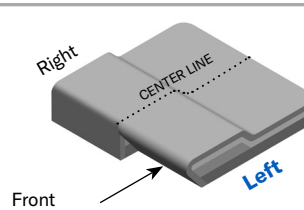

G = 1" D (CD-LEFT-HAM-RELIEF-1)
G = 2" D (CD-LEFT-HAM-RELIEF-2)
G = Other _____ (CD-LEFT-HAM-RELIEF-OTHER)

Right side relief

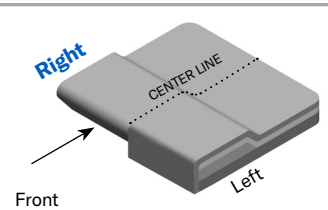

G = 1" D (CD-RIGHT-HAM-RELIEF-1)
G = 2" D (CD-RIGHT-HAM-RELIEF-2)
G = Other _____ (CD-RIGHT-HAM-RELIEF-OTHER)

5.6 Growth notches

MSRP \$42.00

Note: Growth notches may affect any adductors at the rear of the seat support. *Tip: An anti-thrust growth kit from section 2.2 subsection A can be used to adjust the seat well depth as well, if an anti-thrust feature is needed.*

Depth of notches

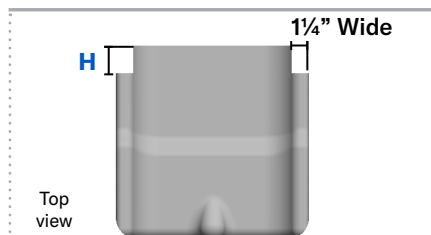

H = 1" D (CD-GROWTH-NOTCH-1)
H = 2" D (CD-GROWTH-NOTCH-2)
H = 3" D (CD-GROWTH-NOTCH-3)
H = Other _____ (CD-GROWTH-NOTCH-OTHER)

5.7 Rail cuts

MSRP \$57.00

Note: Rail cuts will affect how much cushion is left along the sides of especially low-profile seat supports. Cannot be paired with Removable Solid Seat Pan or ATI.

Rail cut height

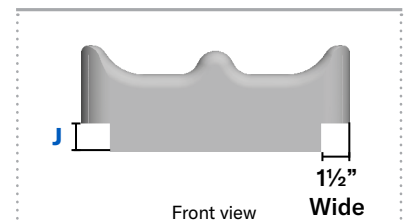

J = 1" Rail cut (CD-RAIL-CUT-1.0)
J = 1 1/2" Rail cut (CD-RAIL-CUT-1.5)
J = 2" Rail cut (CD-RAIL-CUT-2.0)
J = Other _____ (CD-RAIL-CUT-OTHER)

Order #: _____

CD-INCEPTION-FORM REV071223

7 of 10

DO NOT SEND PROTECTED HEALTH INFORMATION. IT IS NOT NEEDED TO MAKE THE PRODUCT YOU ARE REQUESTING.

5.8 Leg length discrepancy

MSRP \$167.00

Note: Offset discrepancy maintains foam abductor shape and removable abductor placement.

Standard leg length discrepancy

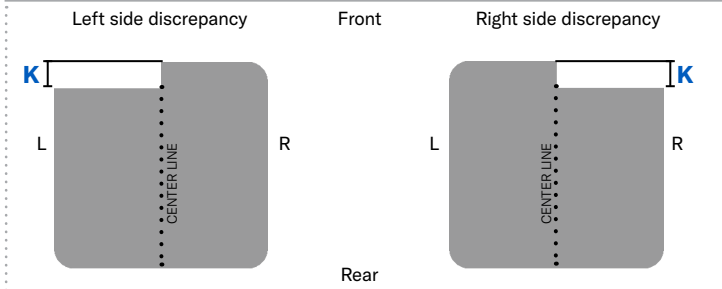

L	Depth removed from side		R
(CD-LLD-DEPTH-L-0.5)	$K = \frac{1}{2}'' D$	(CD-LLD-DEPTH-R-0.5)	
(CD-LLD-DEPTH-L-1.0)	$K = 1'' D$	(CD-LLD-DEPTH-R-1.0)	
(CD-LLD-DEPTH-L-1.5)	$K = 1\frac{1}{2}'' D$	(CD-LLD-DEPTH-R-1.5)	
(CD-LLD-DEPTH-L-2.0)	$K = 2'' D$	(CD-LLD-DEPTH-R-2.0)	
(CD-LLD-DEPTH-L-OTHER)	$K = \text{Other } \underline{\hspace{1cm}}$	(CD-LLD-DEPTH-R-OTHER)	

Offset leg length discrepancy

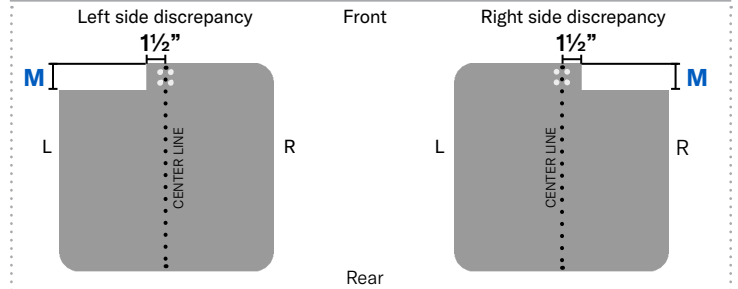

L	Depth removed from side		R
(CD-LLD-O-DEPTH-L-0.5)	$M = \frac{1}{2}'' D$	(CD-LLD-O-DEPTH-R-0.5)	
(CD-LLD-O-DEPTH-L-1.0)	$M = 1'' D$	(CD-LLD-O-DEPTH-R-1.0)	
(CD-LLD-O-DEPTH-L-1.5)	$M = 1\frac{1}{2}'' D$	(CD-LLD-O-DEPTH-R-1.5)	
(CD-LLD-O-DEPTH-L-2.0)	$M = 2'' D$	(CD-LLD-O-DEPTH-R-2.0)	
(CD-LLD-O-DEPTH-L-OTHER)	$M = \text{Other } \underline{\hspace{1cm}}$	(CD-LLD-O-DEPTH-R-OTHER)	

5.9 Platform

MSRP \$828.00

Note: Accommodates 7/8" or 1" tubing. Comes with two different cross bars to accommodate various wheelchair frame types. Fits both folding and non-folding seat rails. Lateral pelvic/thigh support hardware can be easily attached. Cannot be paired with rail cut. Leg length discrepancy offset maintains centered removable abductor hardware attachment.

Removable solid seat pan

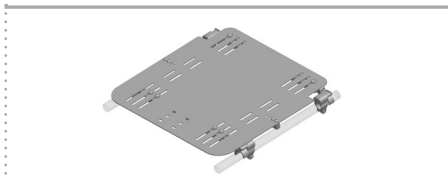

Solid seat pan (CD-RSP-N-HARD)
Solid seat pan w/standard leg discrepancy (CD-RSP-STND-LLD)
Solid seat pan w/offset leg discrepancy (CD-RSP-OFF-LLD)

5.10 Insert

Note: Moldable ATI (Adjustable Technology Insert for Positioning) enables on-site customization to the contour of the seat support surface. 1/4" Crosslink is not recommended with the ATI. Cannot be paired with rail cuts.

Moldable ATI

MSRP \$310.00

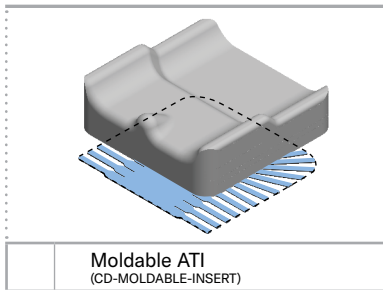

Moldable ATI
(CD-MOLDABLE-INSERT)

Note: Cannot be paired with the round bottom in section 2.1.

Rigid insert

MSRP \$135.00

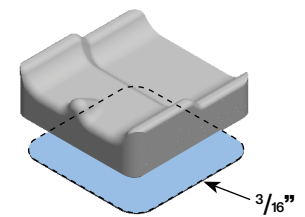

Rigid insert glued (CD-RGD-INSERT-GLUED)
Rigid insert not glued (CD-RGD-INSERT-UNGLUED)

Order #: _____

CD-INCEPTION-FORM REV071223

8 of 10

DO NOT SEND PROTECTED HEALTH INFORMATION. IT IS NOT NEEDED TO MAKE THE PRODUCT YOU ARE REQUESTING.

6 Cover accessories

6.1 Zippered pouch

MSRP \$57.00

Zippered pouch (CD-ZIP-POUCH)

6.2 Colored piping

MSRP \$0.00

Note: If no color is selected, our standard silver reflective piping will be used.

Red (CD-RED)
Purple (CD-PURPLE)
Pink (CD-PINK)
Orange (CD-ORANGE)

Blue (CD-BLUE)
Green (CD-GREEN)
Remove (CD-REMOVE)

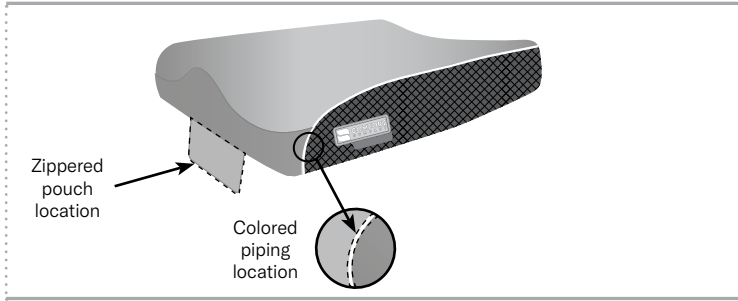

7 Additional information

7.1 Comments

Instructions: Please reference any section or subsection of the form when making any comments.

Section #	Page #	Comments

Instructions: If preferred, please sketch ideas in the spaces provided below.

Submit by email

Order #: _____

CD-INCEPTION-FORM REV071223

10 of 10

DO NOT SEND PROTECTED HEALTH INFORMATION. IT IS NOT NEEDED TO MAKE THE PRODUCT YOU ARE REQUESTING.